

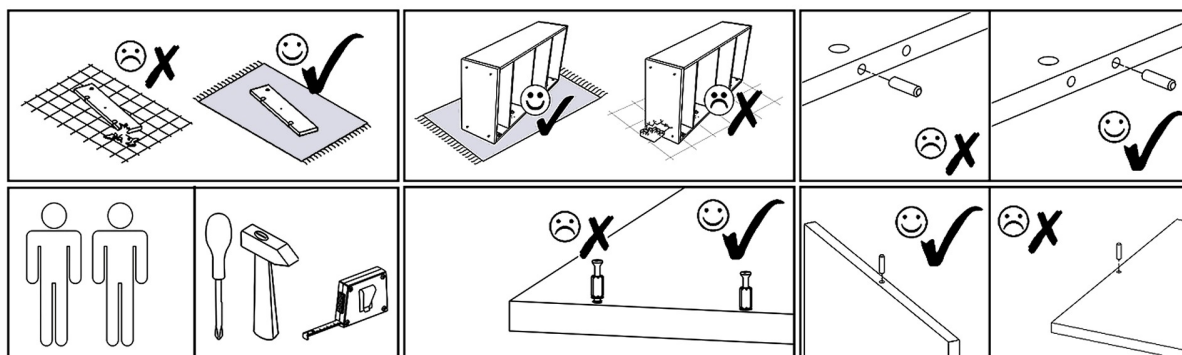

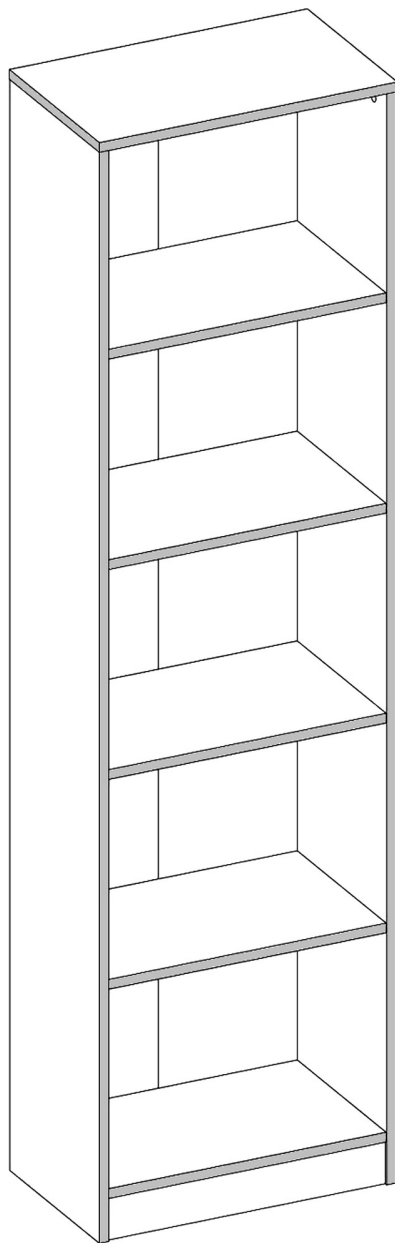











R50

PRODUCTION DATE

PACKING CODE



B1  B ø17/4mm x4	B1  S/A ø17/4mm x4	B1  CZ ø17/4mm x4	B1  Ant ø17/4mm x4	B1  K ø17/4mm x4	B1  G ø17/4mm x4
---	---	--	---	---	--

M1  12x15mm x12	N1  L=35mm x12	E1  8x30mm x16	Z1  x50	V16  5x16mm x12	T1  x4	V32  L=1712mm x1	V13  x1
---	--	--	---	---	---	--	---





R50

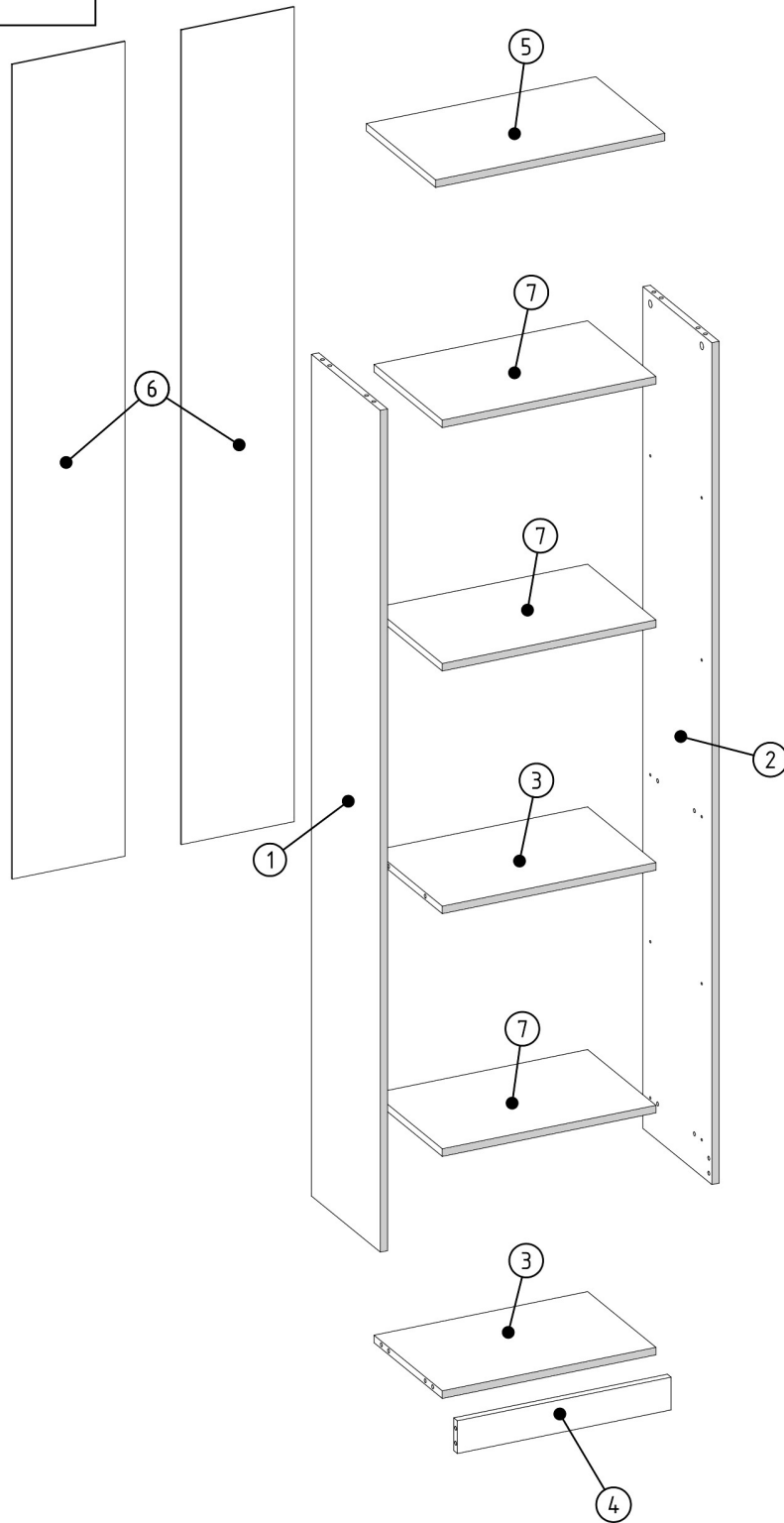



PRODUCTION DATE

PACKING CODE



000516	7	3
000515	6	2
000518	5	1
000514	4	1
000517	3	2
000513	2	1
000512	1	1
ID	NUMBER	QUANTITY





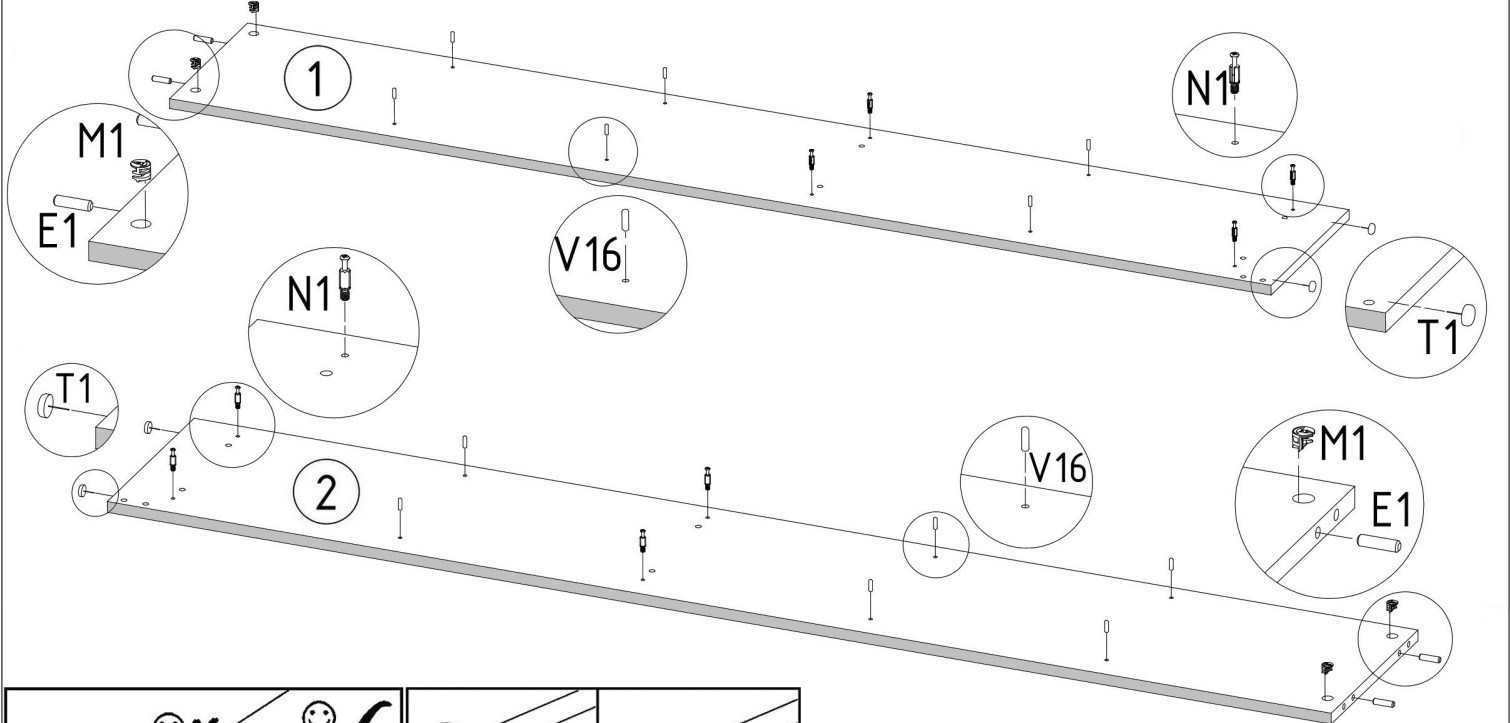



M1  12x15mm	E1  x4 8x30mm	V16  x4 5x16mm	N1  x12 L=35mm	T1  x4
---	---	--	--	--



  ✓	  ✗
--	---



1

2





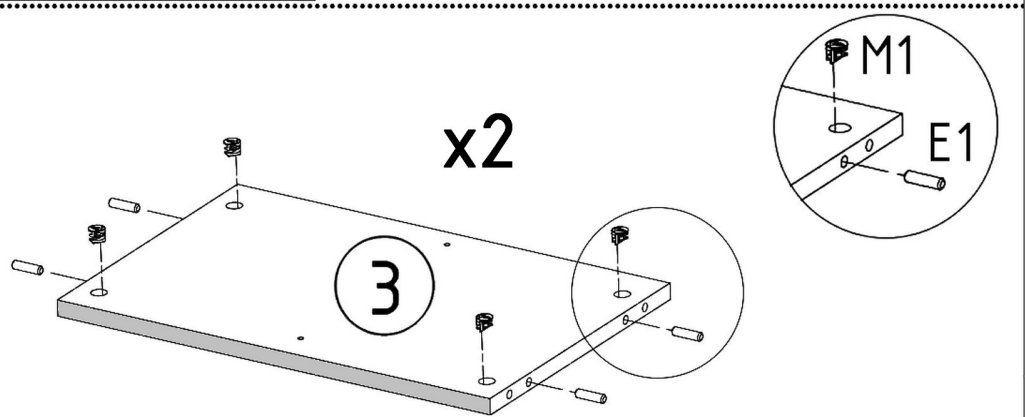

 ✗	 ✗	 ✗	 ✗
 ✗	 ✗	 ✗	 ✗

M1  12x15mm	E1  x8 8x30mm
---	---



3

x2

 ✗	 ✗	  ✓	  ✗
---	---	--	---

E1  8x30mm	x4
---	----

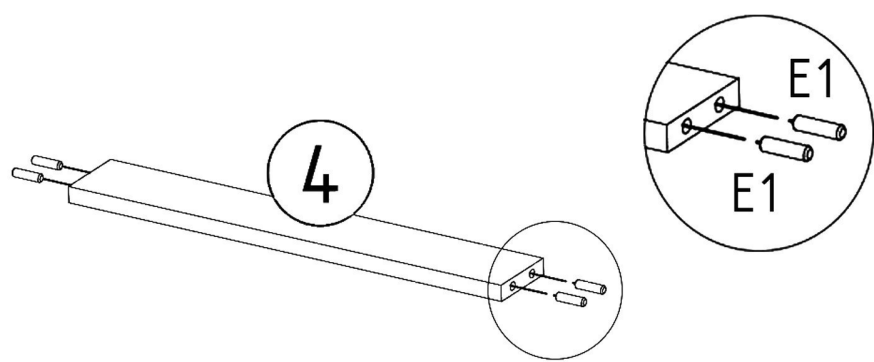

4

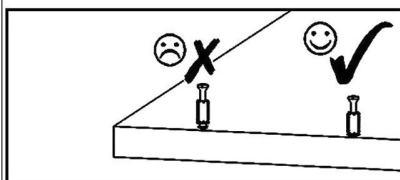
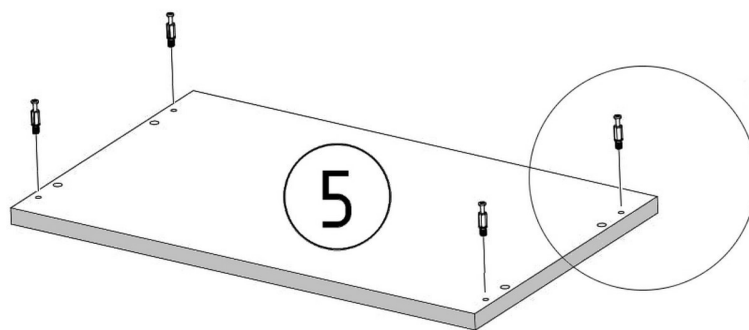
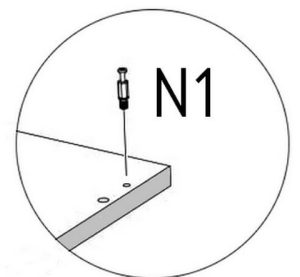
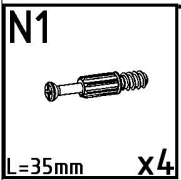
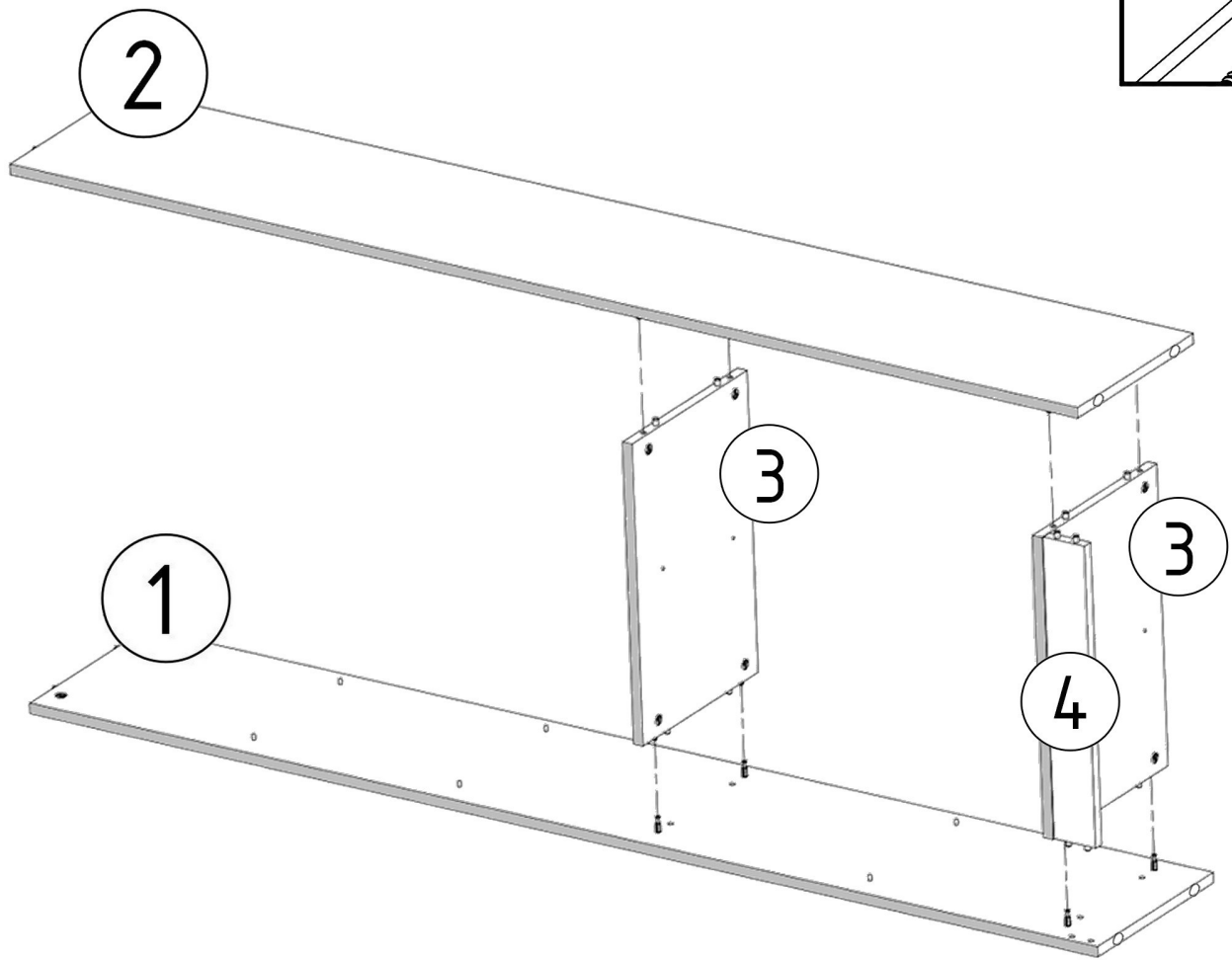
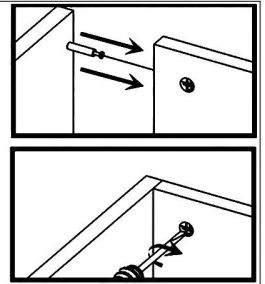

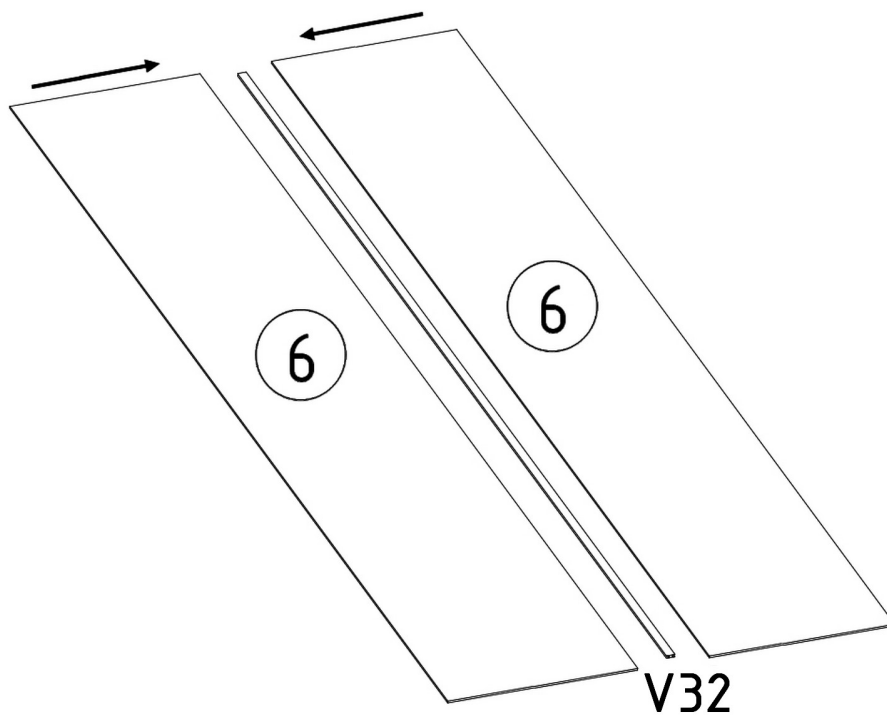
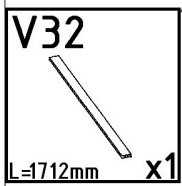
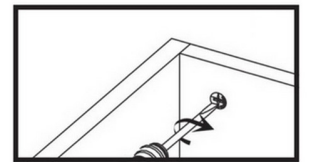
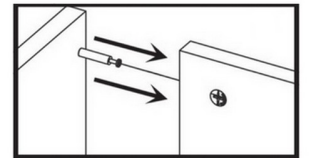
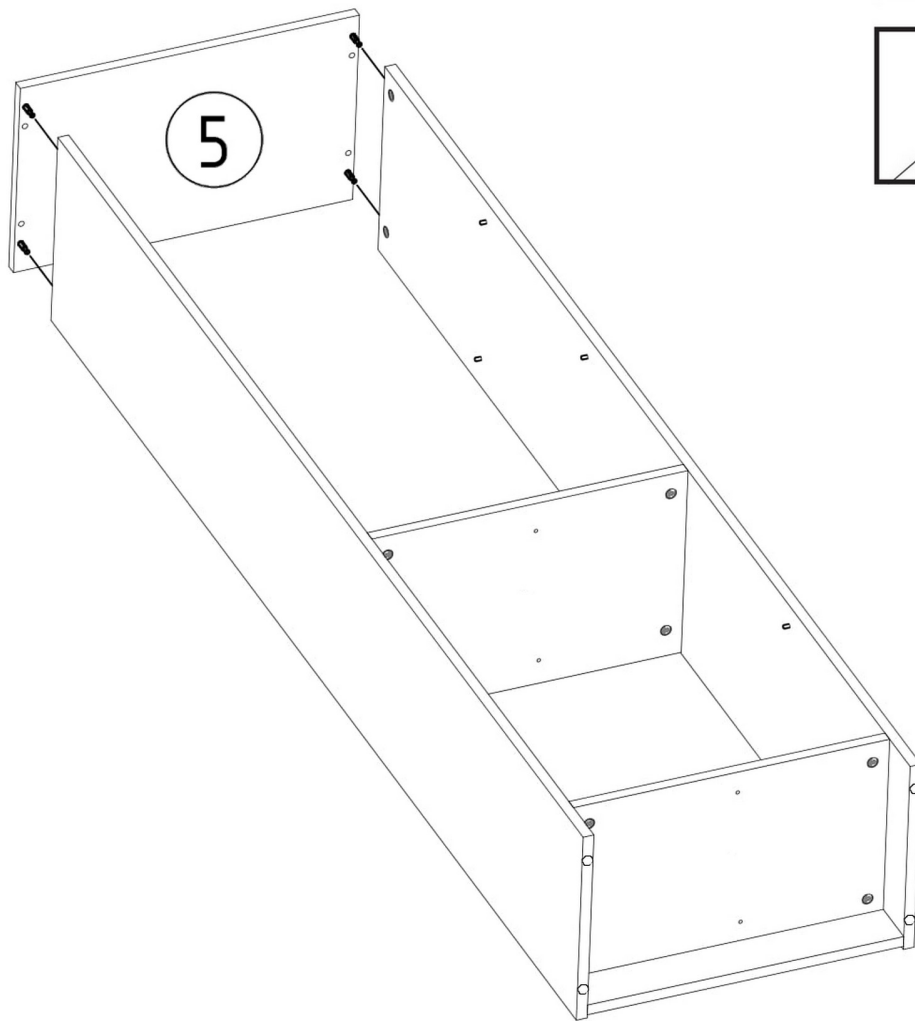

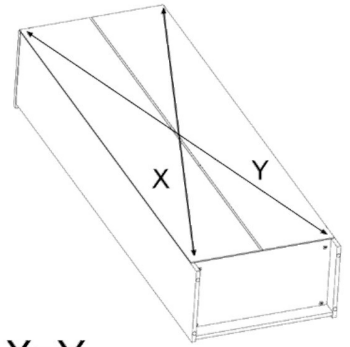
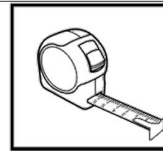

Z1
x50

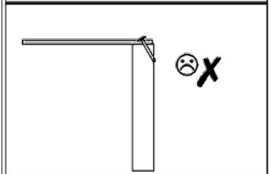
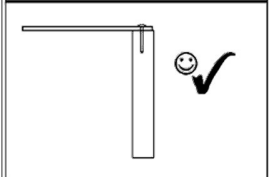
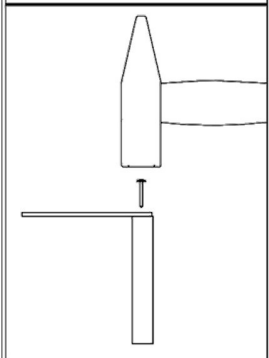
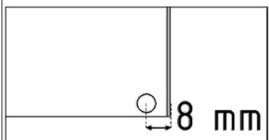
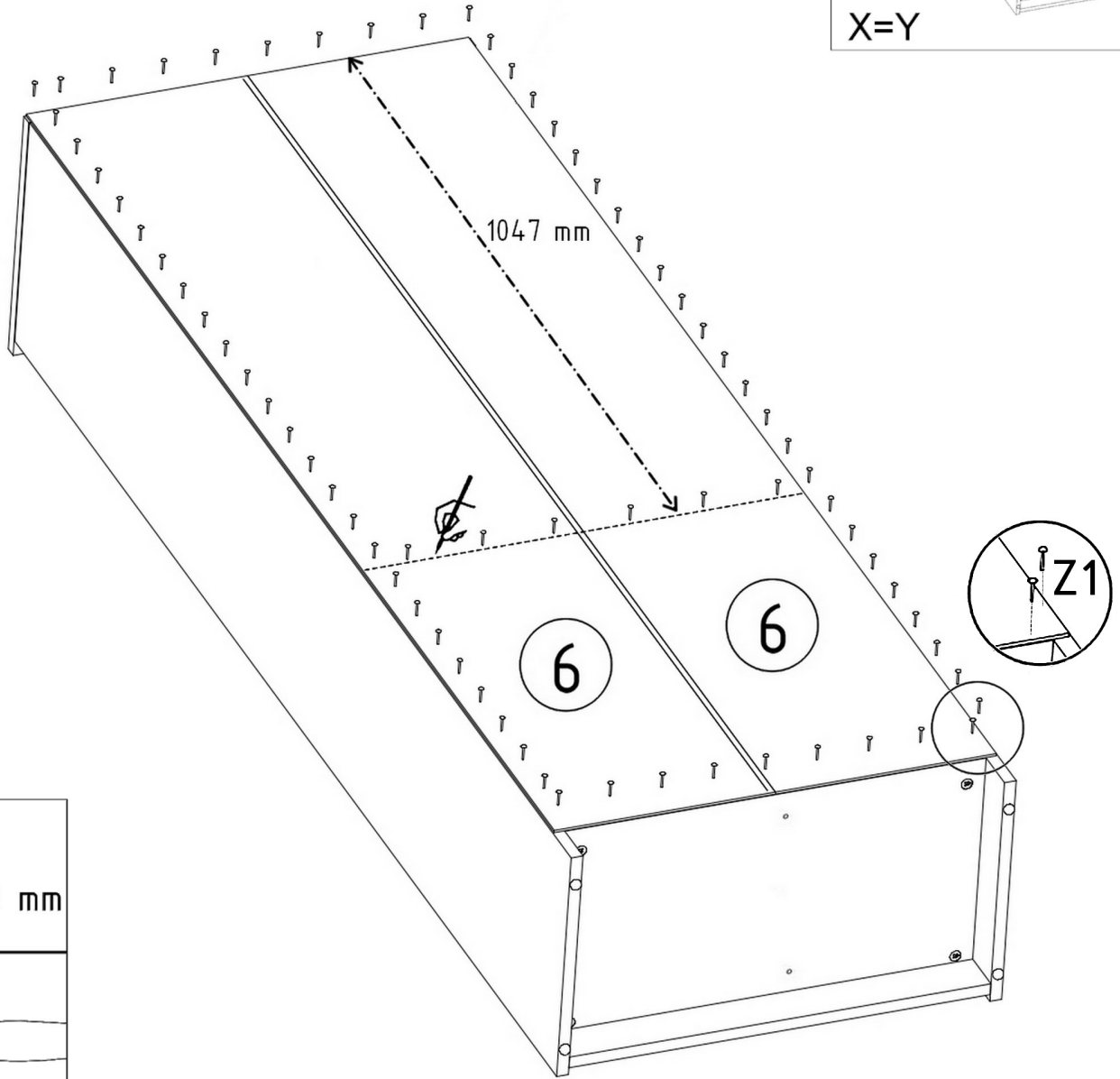

X=Y



V13  X1 $\sigma 17/4mm$ X4	B1  X4
--	--

