

# POLA\_MULTI

PRODUCTION DATE

PACKING CODE

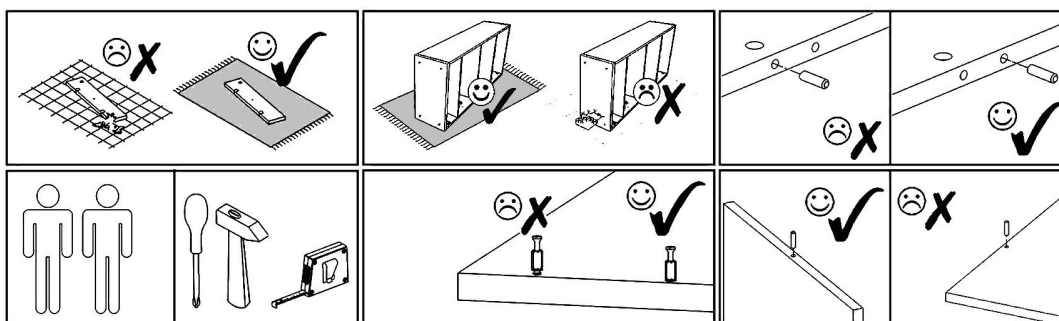
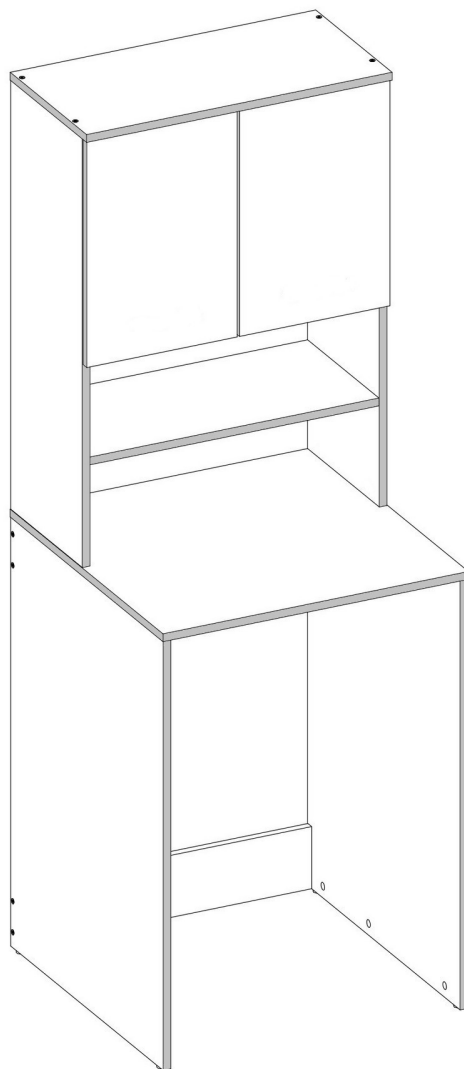

<b>B1</b>  Ant. $\phi 17/4mm$ x12	<b>B1</b>  K $\phi 17/4mm$ x12	<b>B2</b>  B $\phi 12/4mm$ x8	<b>B2</b>  S/A $\phi 12/4mm$ x8				
<b>T1</b>  x4	<b>Z1</b>  x30	<b>V41</b>  x1	<b>A1</b>  ZP x4	<b>N4</b>  L=62mm x4	<b>B1</b>  B $\phi 17/4mm$ x12	<b>B1</b>  S/A $\phi 17/4mm$ x12	<b>B2</b>  K $\phi 12/4mm$ x8
<b>M1</b>  12x15mm x18	<b>N1</b>  L=35mm x10	<b>E1</b>  8x30mm x16	<b>E3</b>  8x50mm x2	<b>F1</b>  7x50mm x12	<b>F3</b>  Hex 4mm x1	<b>S1</b>  3,5x16mm x10	<b>B2</b>  Ant. $\phi 12/4mm$ x8

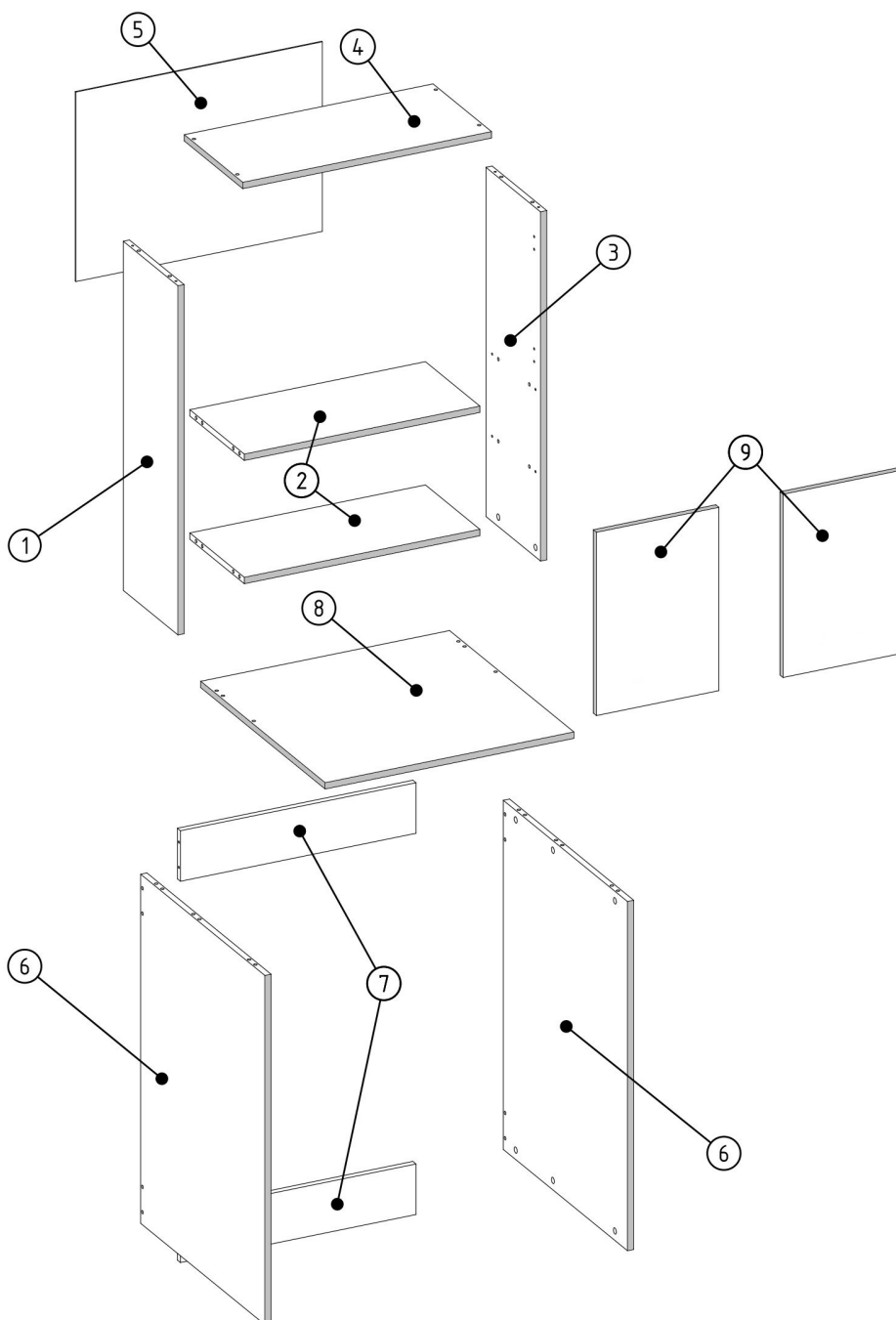

001656	9	2
001658	8	1
000130	7	2
001648	6	2
001655	5	1
001654	4	1
001653	3	1
000128	2	2
001652	1	1
ID	NUMBER	QUANTITY

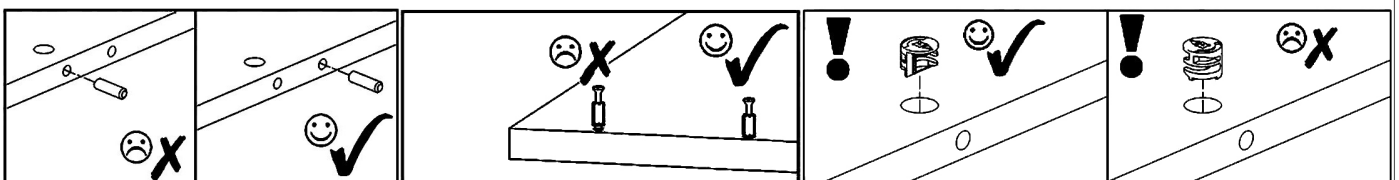
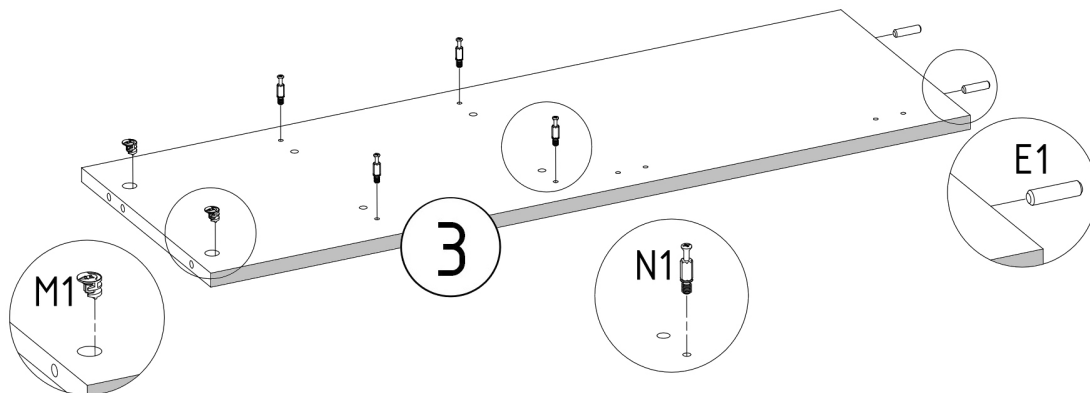
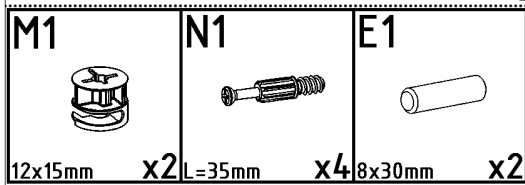
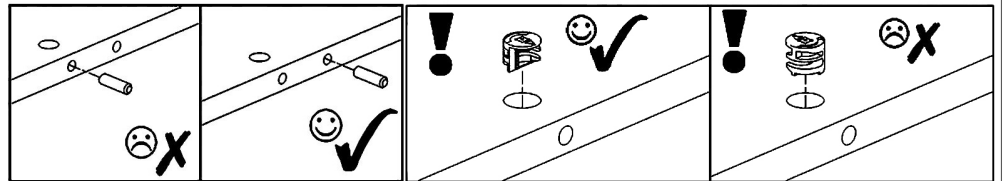
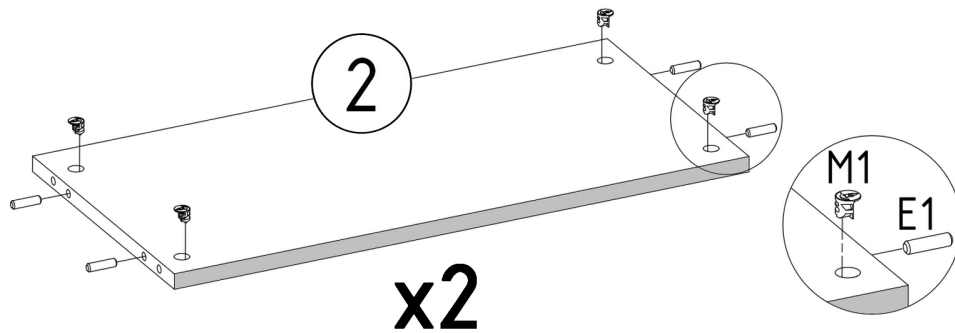
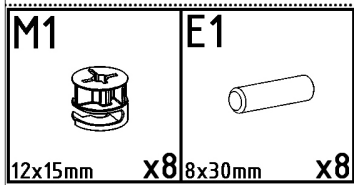
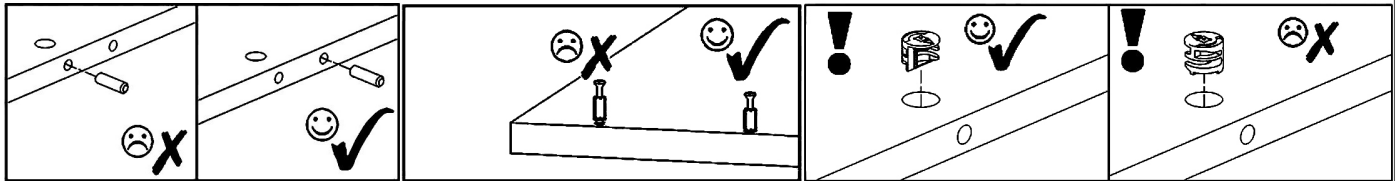
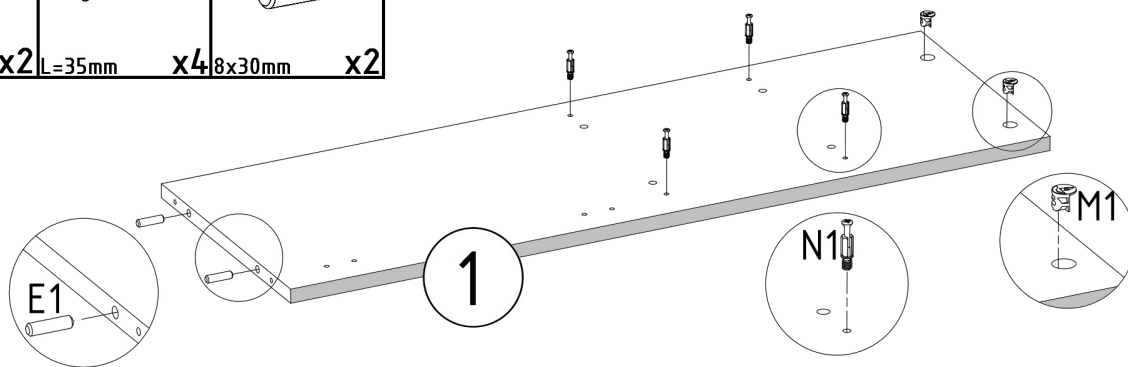
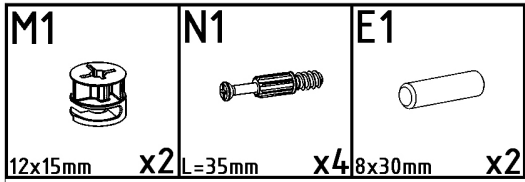

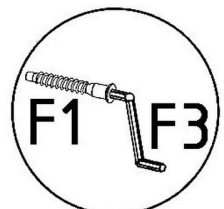
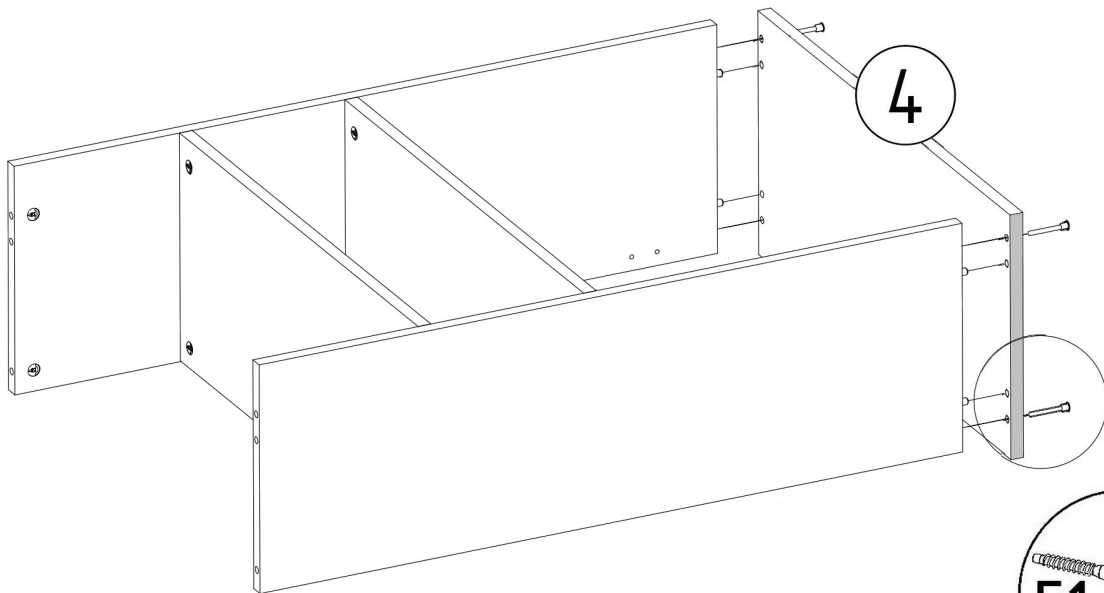
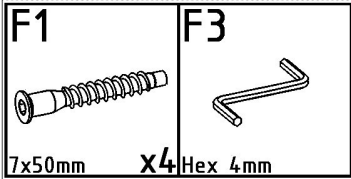
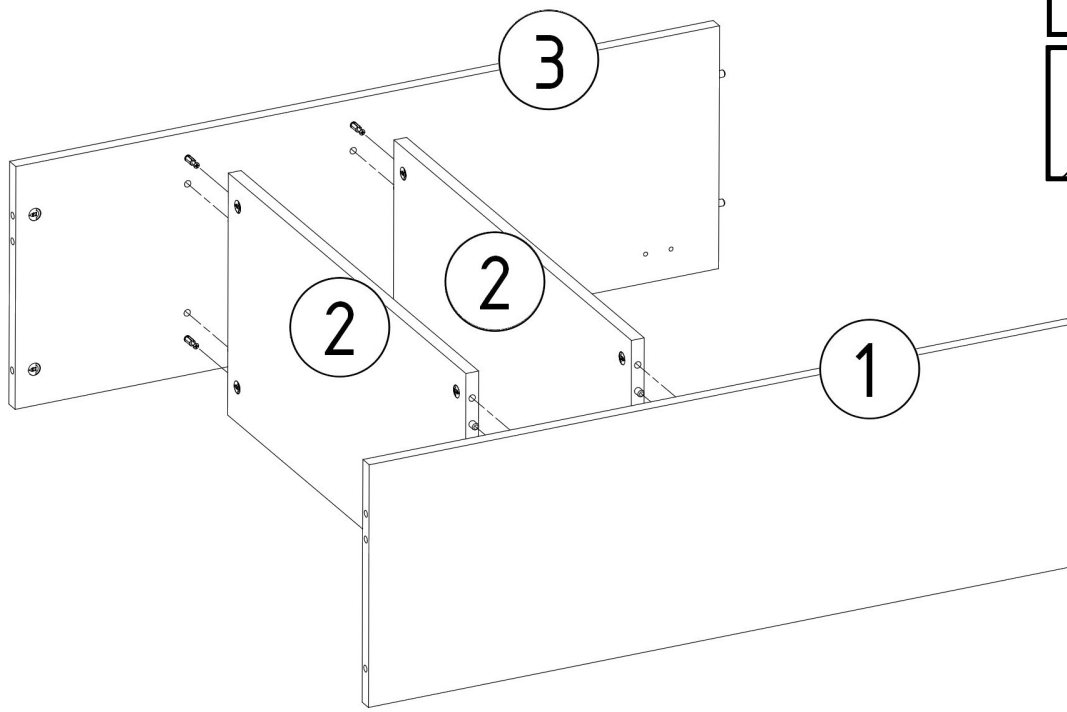

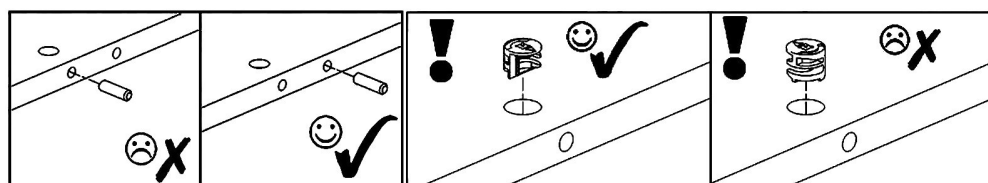
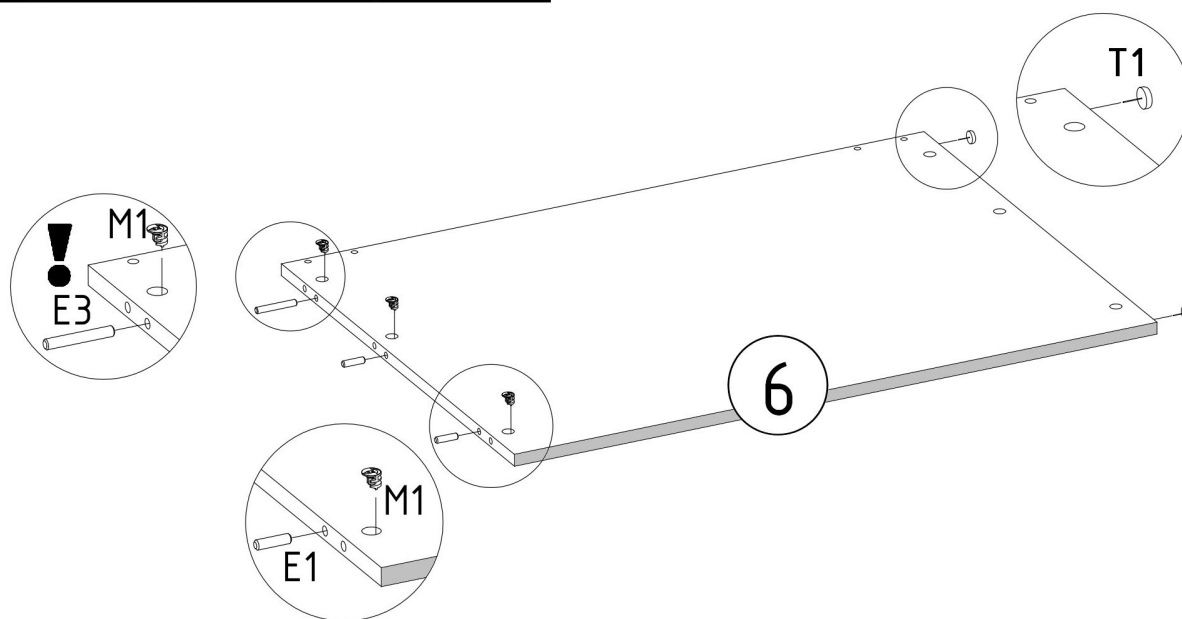
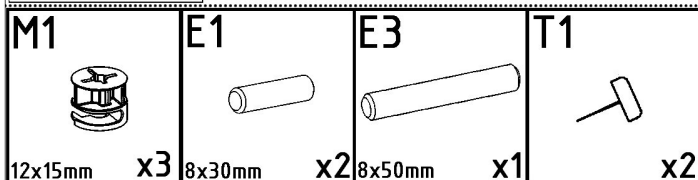
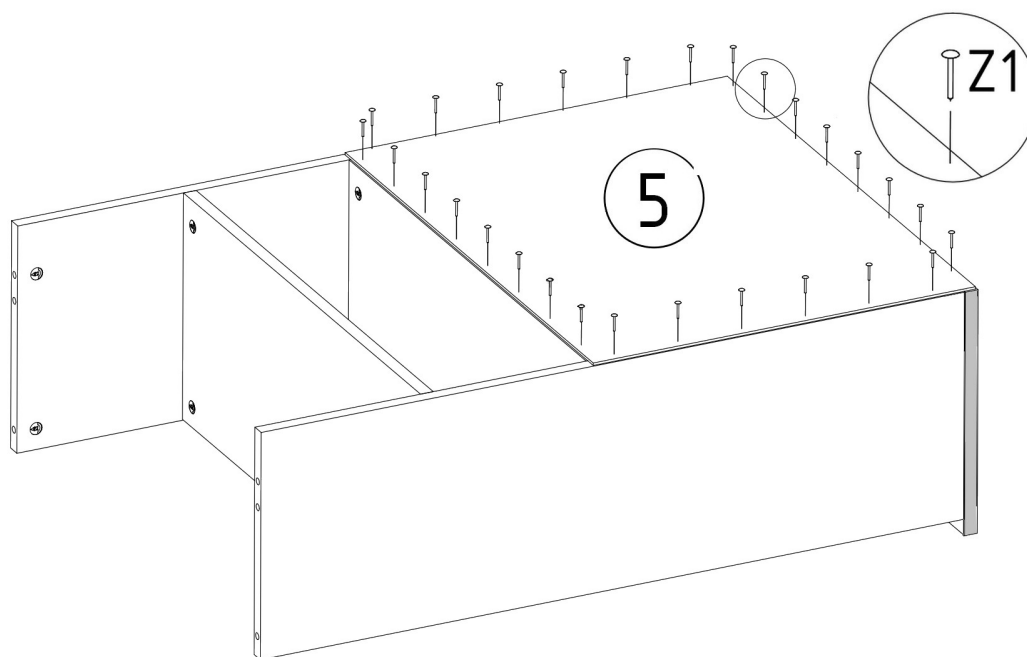
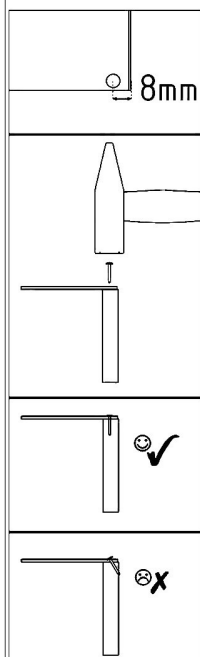
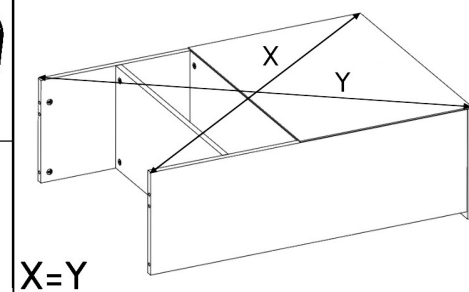
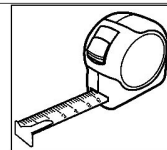
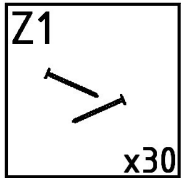

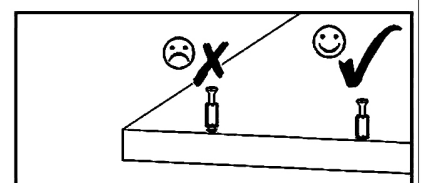
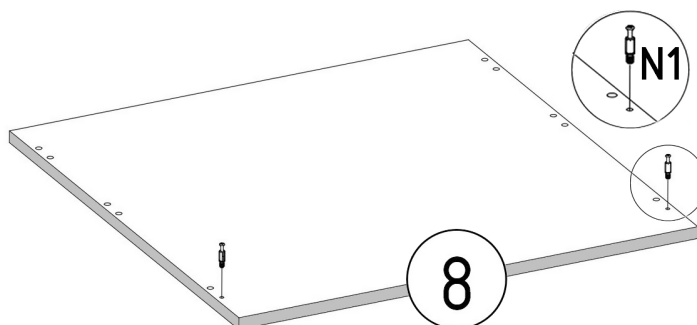
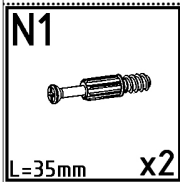
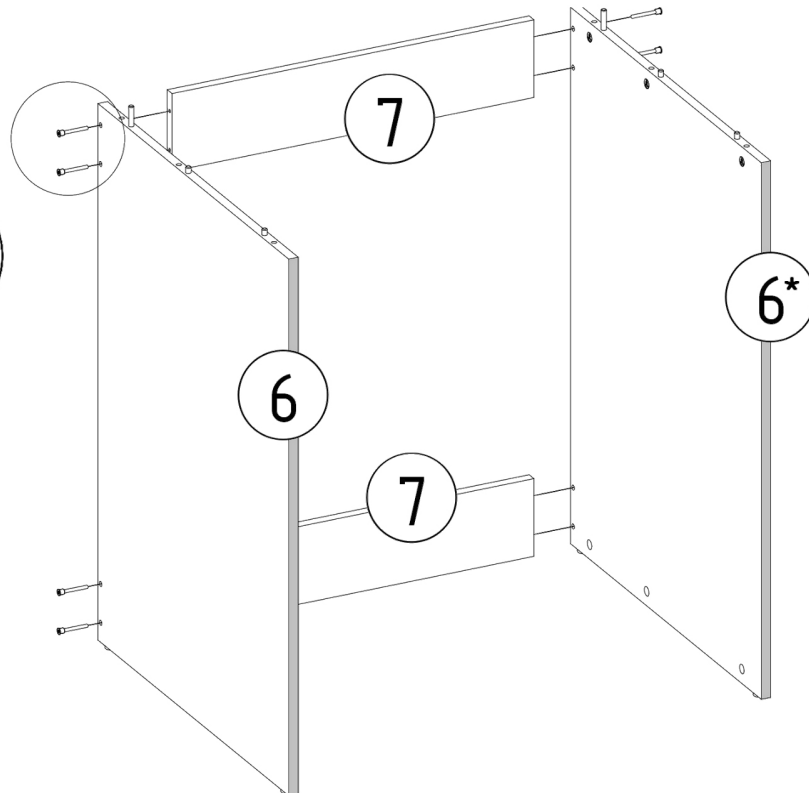
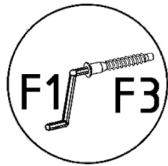
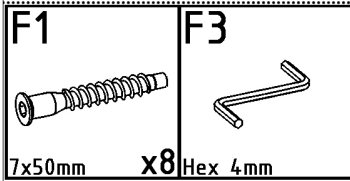
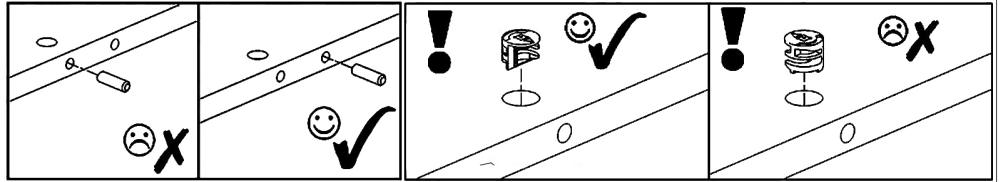
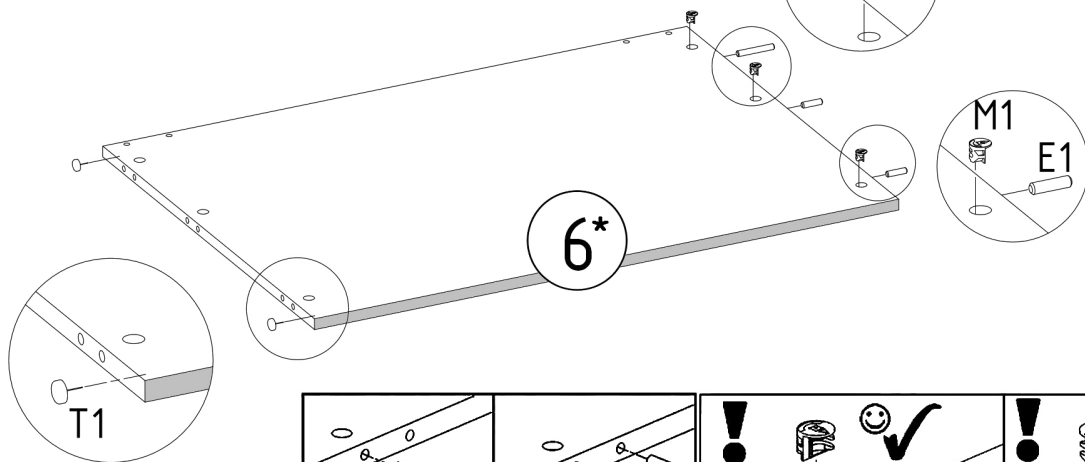
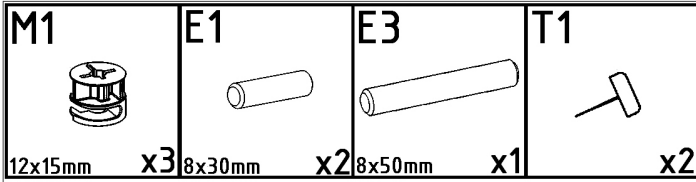

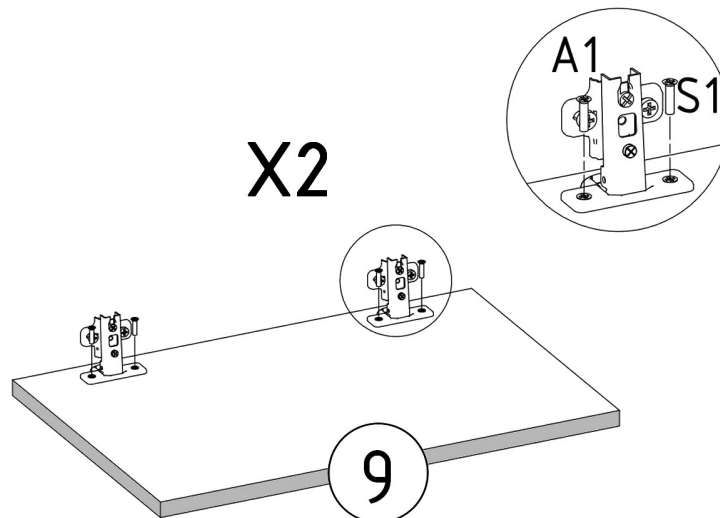
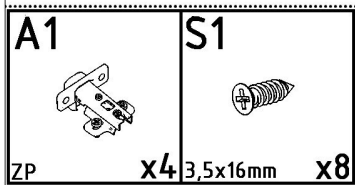
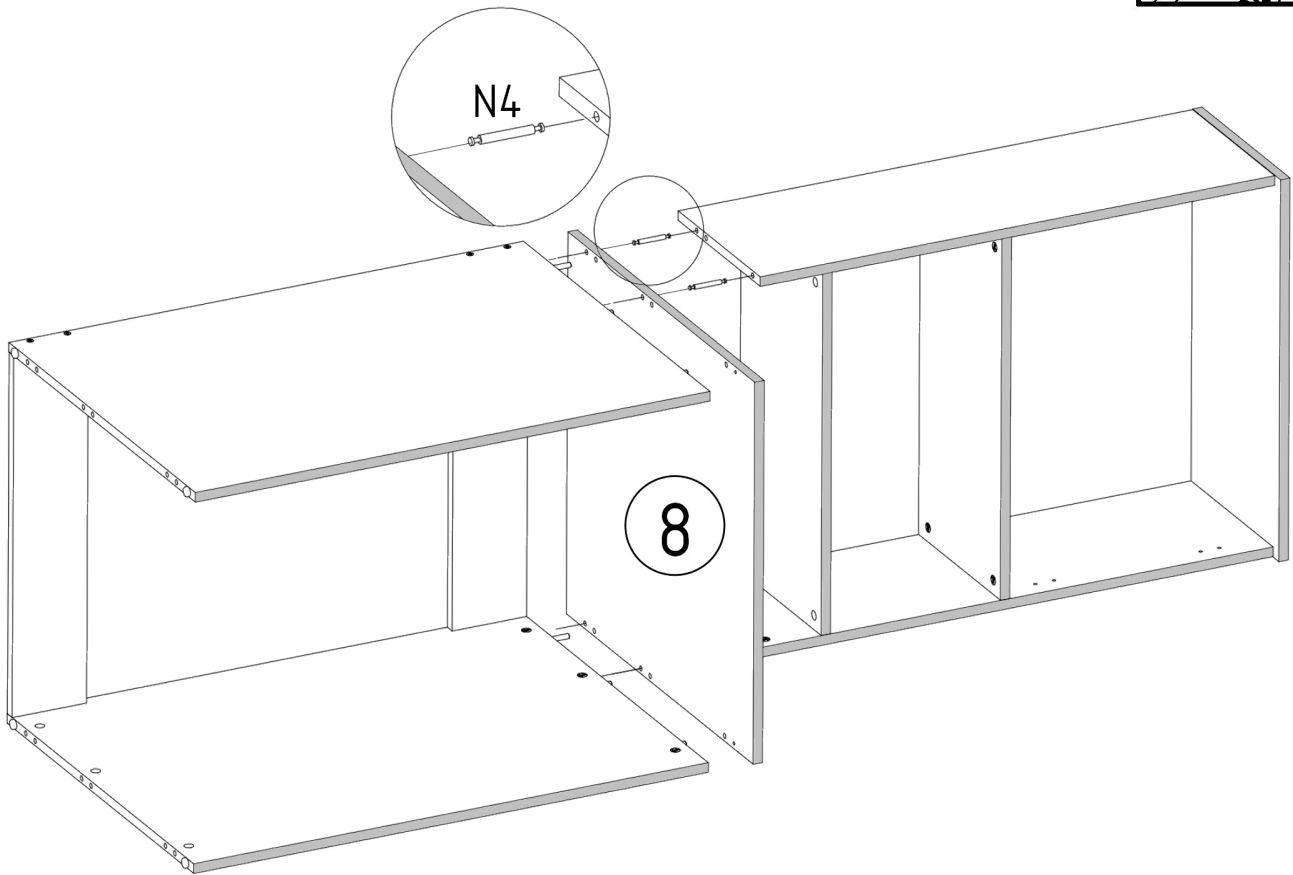
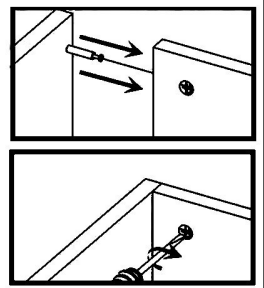
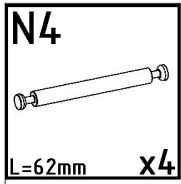









<p><b>B1</b></p>  <p>ø17/4mm x12</p>	<p><b>B2</b></p>  <p>ø12/4mm x8</p>	<p><b>V41</b></p>  <p>x1</p>
----------------------------------------------------------------------------------------------------------------------	----------------------------------------------------------------------------------------------------------------------	--------------------------------------------------------------------------------------------------------------

**S1**

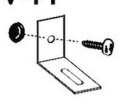

3,5x16mm x2

				<p><b>V41</b></p> 
----------------------------------------------------------------------------------	----------------------------------------------------------------------------------	------------------------------------------------------------------------------------	------------------------------------------------------------------------------------	------------------------------------------------------------------------------------------------------

