

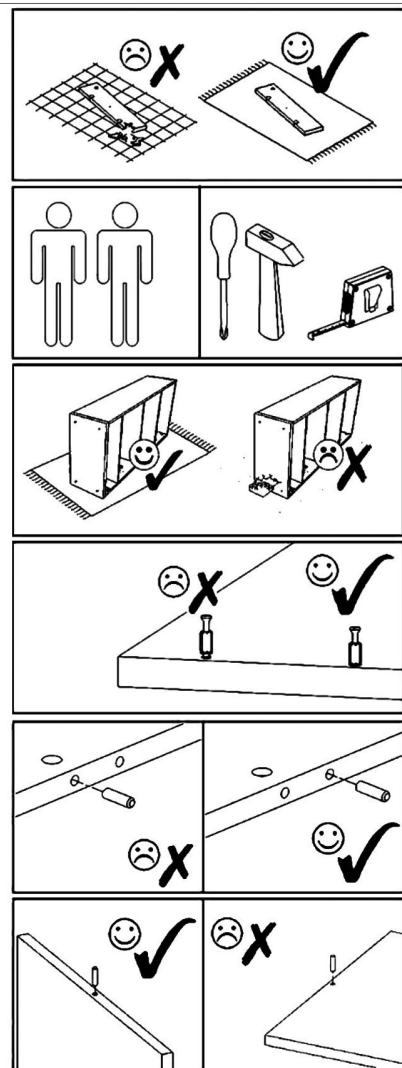

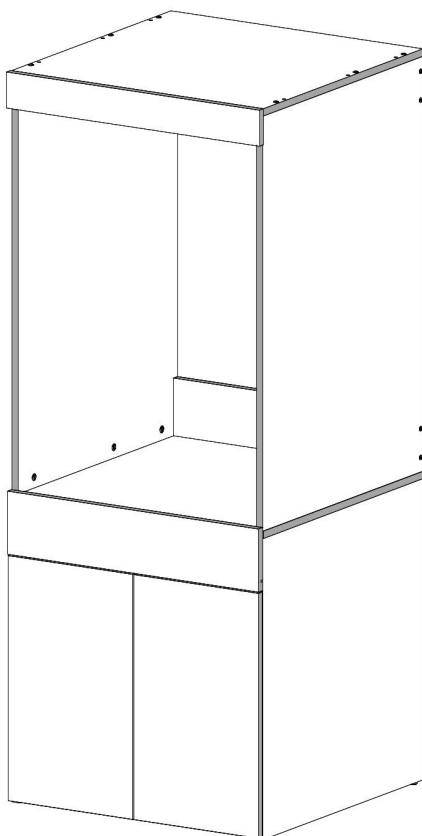











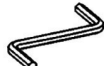



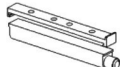







POLA TWIN 1S

PRODUCTION DATE

PACKING CODE



<p>B4</p>  <p>B ø12/8,5mm x6</p>	<p>B4</p>  <p>K ø12/8,5mm x6</p>	<p>B4</p>  <p>S/A ø12/8,5mm x6</p>	<p>B4</p>  <p>Ant ø12/8,5mm x6</p>				
<p>F1</p>  <p>7x50mm x10</p>	<p>F3</p>  <p>Hex 4mm x1</p>	<p>R1</p>  <p>6x8mm x4</p>	<p>S1</p>  <p>3,5x16mm x26</p>	<p>V39</p>  <p>x2</p>	<p>V41</p>  <p>x1</p>		
<p>V62</p>  <p>x2</p>	<p>A1</p>  <p>ZP x4</p>	<p>Z1</p>  <p>x50</p>	<p>N4</p>  <p>L=62mm x6</p>	<p>M1</p>  <p>12x15mm x28</p>	<p>N7</p>  <p>L=41mm x6</p>	<p>E1</p>  <p>8x30mm x14</p>	<p>N1</p>  <p>L=35mm x10</p>
<p>B1</p>  <p>B ø17/4mm x2</p>	<p>T1</p>  <p>x4</p>	<p>P3</p>  <p>L=350mm x1</p>	<p>B2</p>  <p>Ant ø12/4mm x8</p>	<p>B2</p>  <p>S/A ø12/4mm x8</p>	<p>B2</p>  <p>B ø12/4mm x8</p>	<p>B2</p>  <p>K ø12/4mm x8</p>	<p>E3</p>  <p>8x50mm x6</p>

POLA TWIN 1S





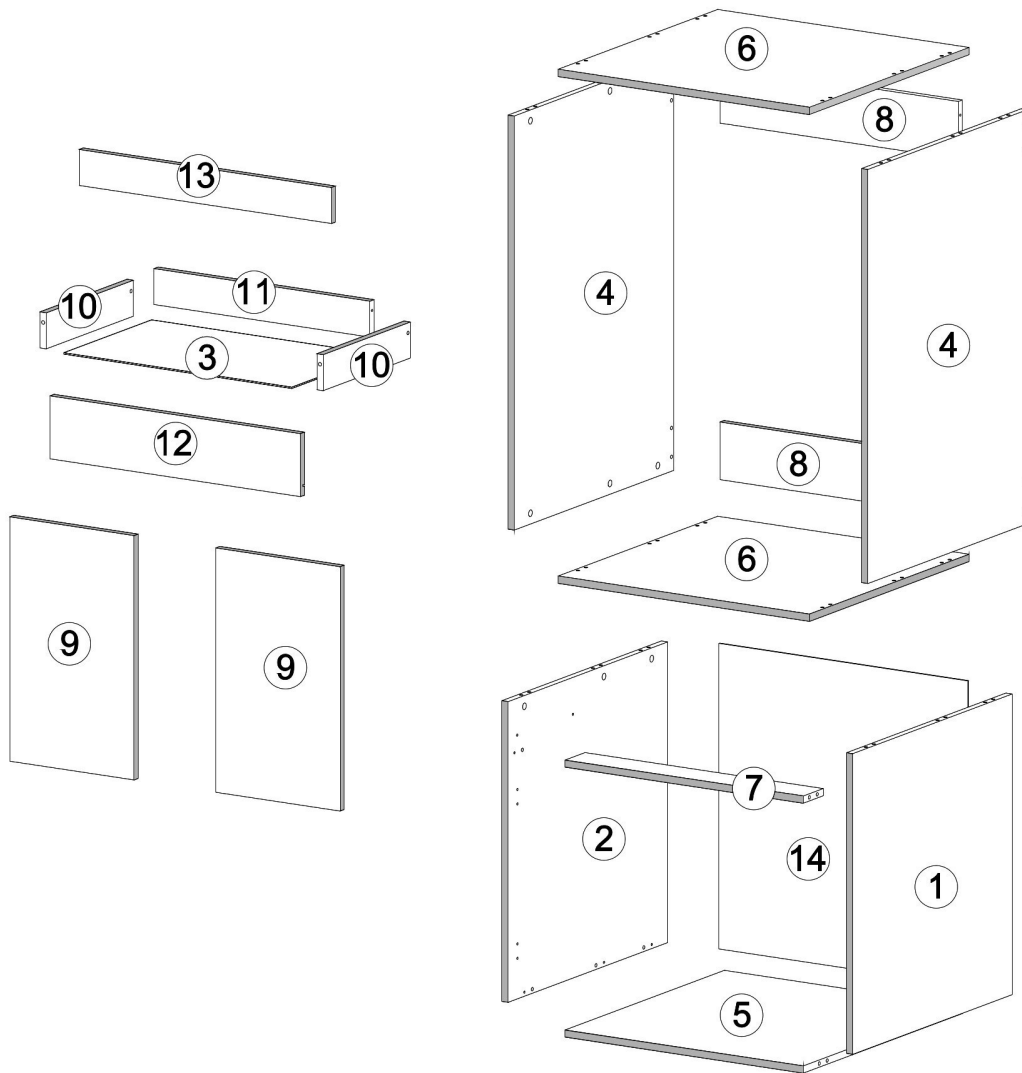

PRODUCTION DATE

PACKING CODE







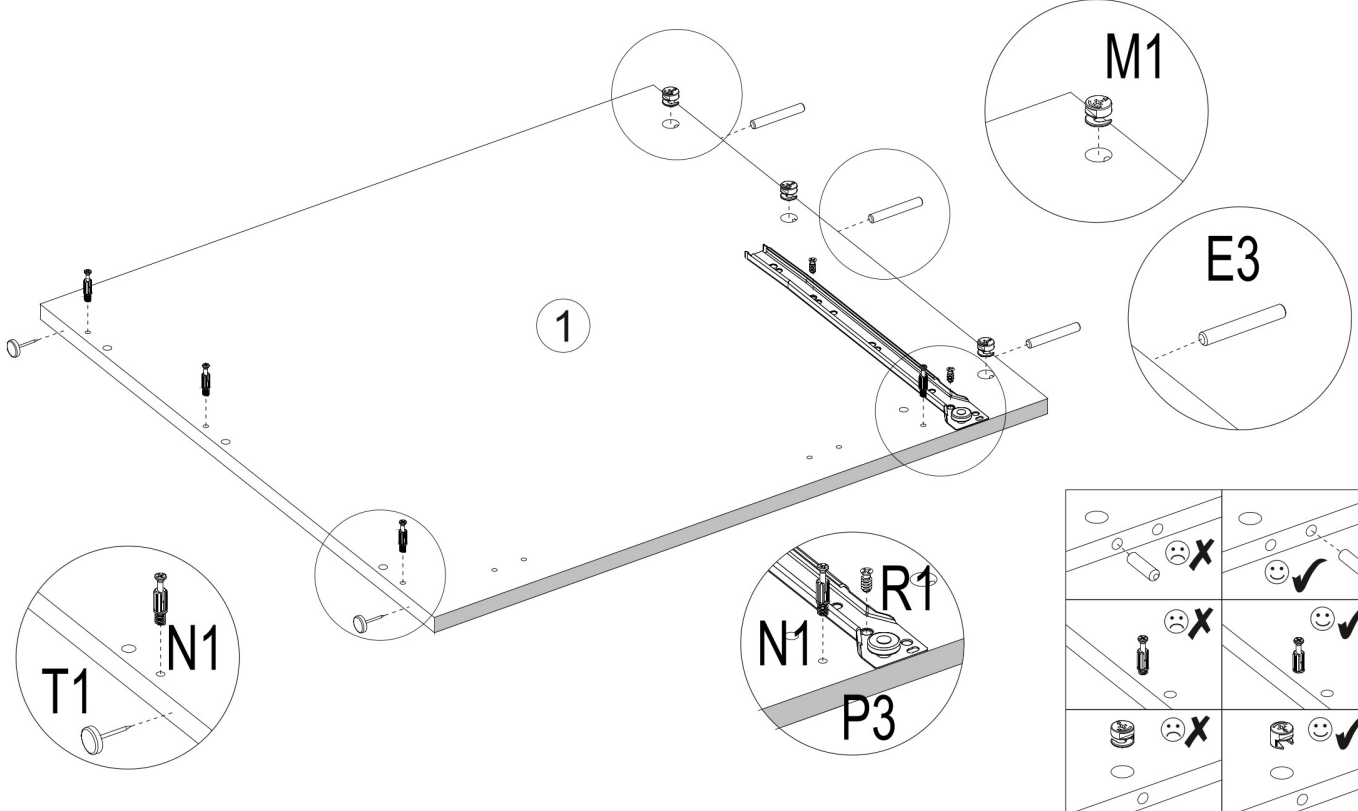

001983	1	1
001981	2	1
001988	3	1
001982	4	2
001990	5	1
002184	6	2
000130	7	1
001986	8	2
000056	9	2
ID	NUMBER	QUANTITY

002000	10	2
001987	11	1
001985	12	1
002225	13	1
001999	14	1

E3  8x50mm x3	N1  L=35mm x4	T1  x2	M1  12x15mm x3	P3  L=350mm x1	R1  6x8mm x2
---	--	---	---	---	---



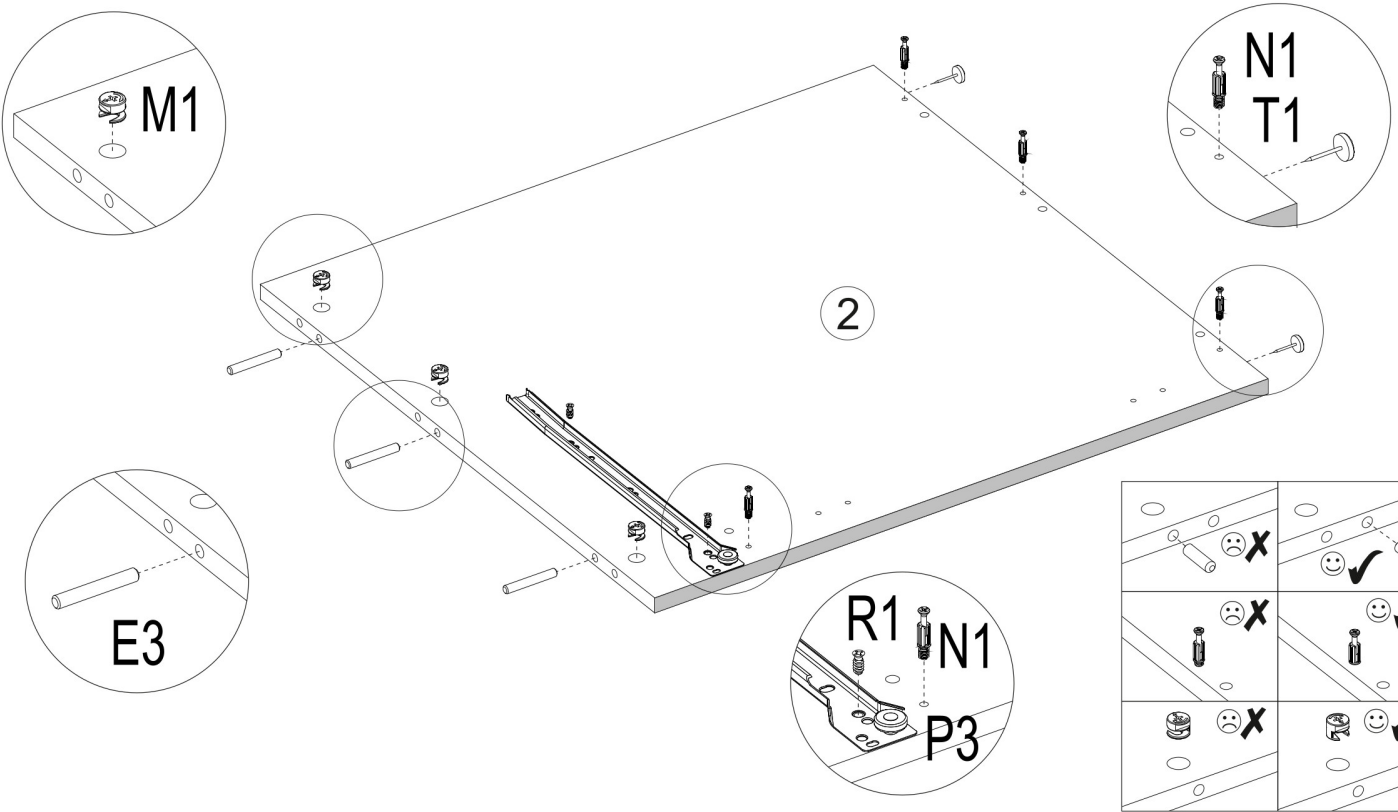

E3  8x50mm x3	N1  L=35mm x4	T1  x2	M1  12x15mm x3	P3  L=350mm x1	R1  6x8mm x2
---	--	---	---	---	---

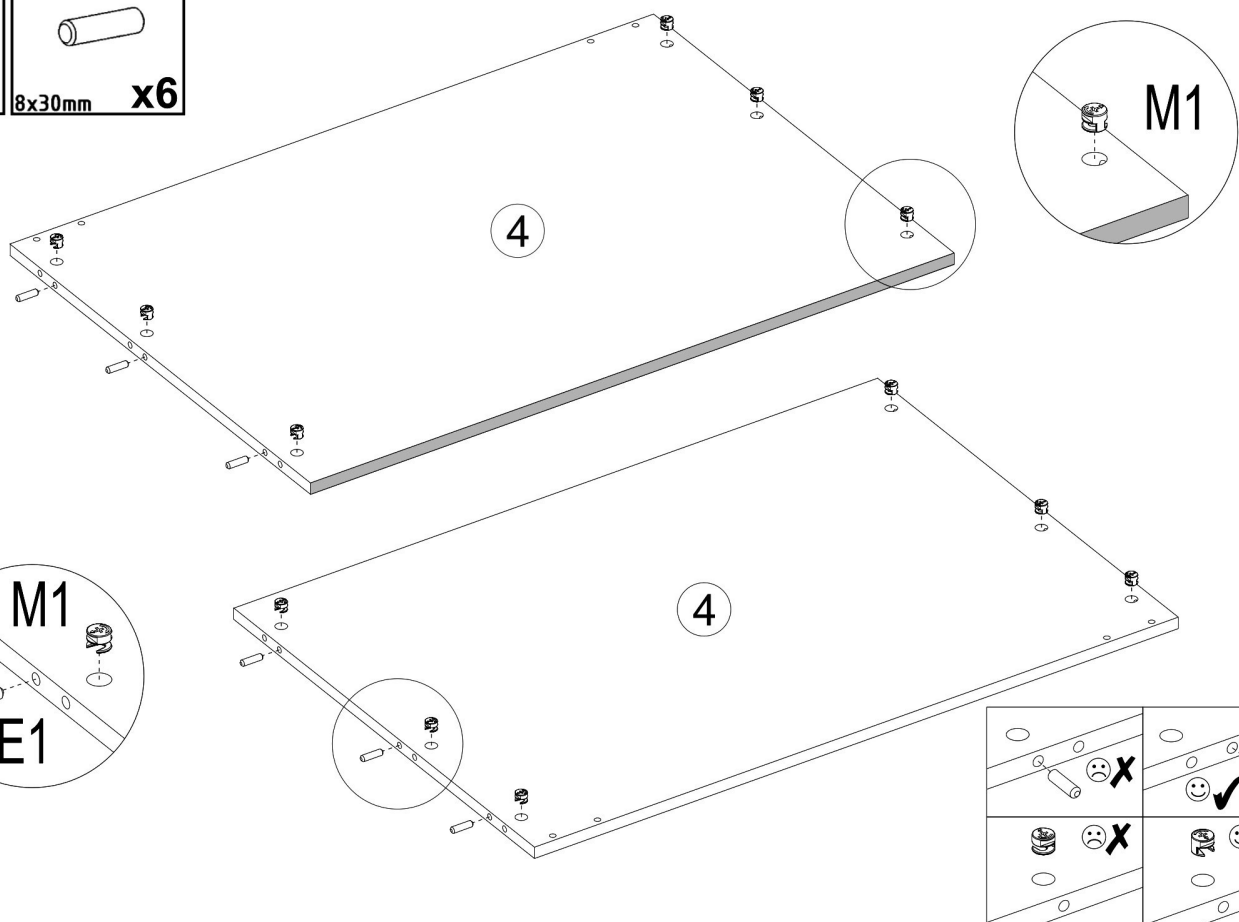

M1

 12x15mm **x12**

E1

 8x30mm **x6**

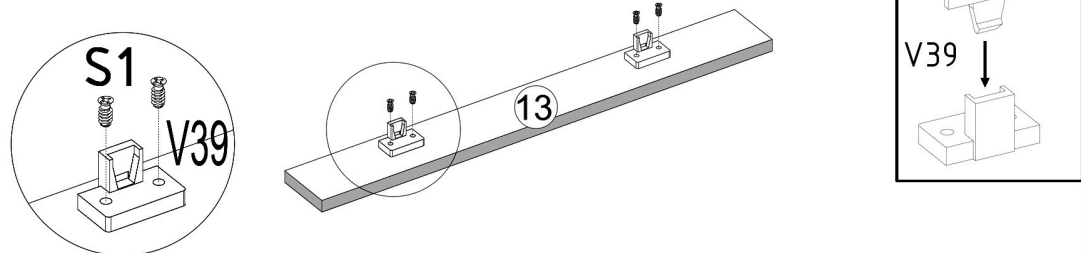

S1

 3,5x16mm **x4**



V39

x2

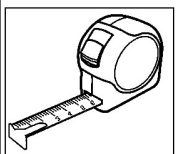
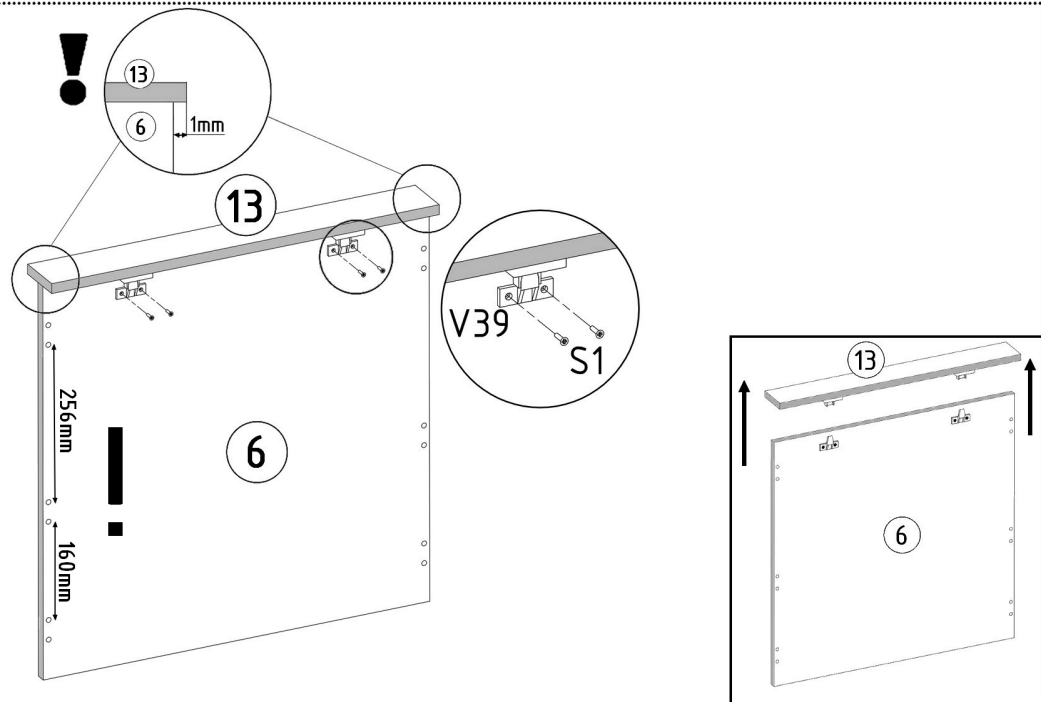





S1

 3,5x16mm **x4**

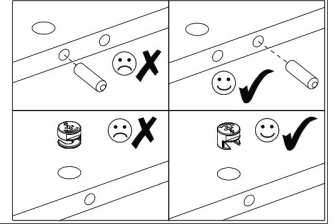
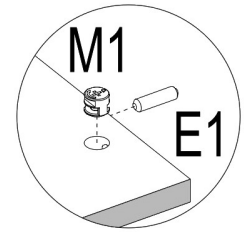
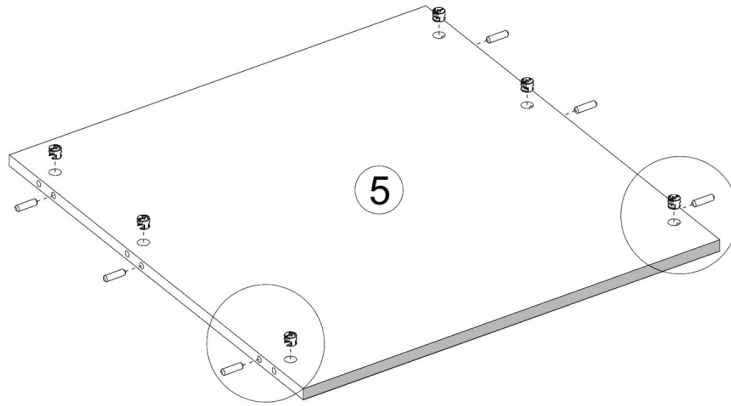
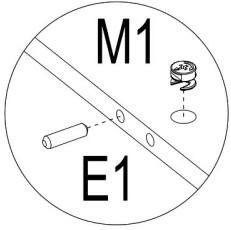
V39

x2

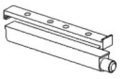

M1  12x15mm x6	E1  8x30mm x6
---	--



S1  3,5x16mm x4	V62  x2	M1  12x15mm x2	E1  8x30mm x2
--	--	---	--

