

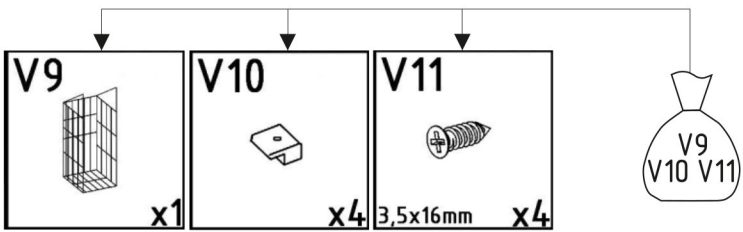

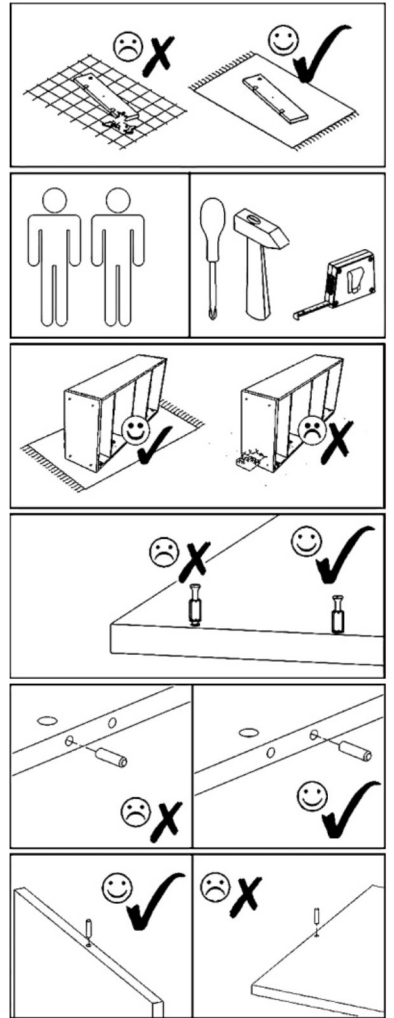

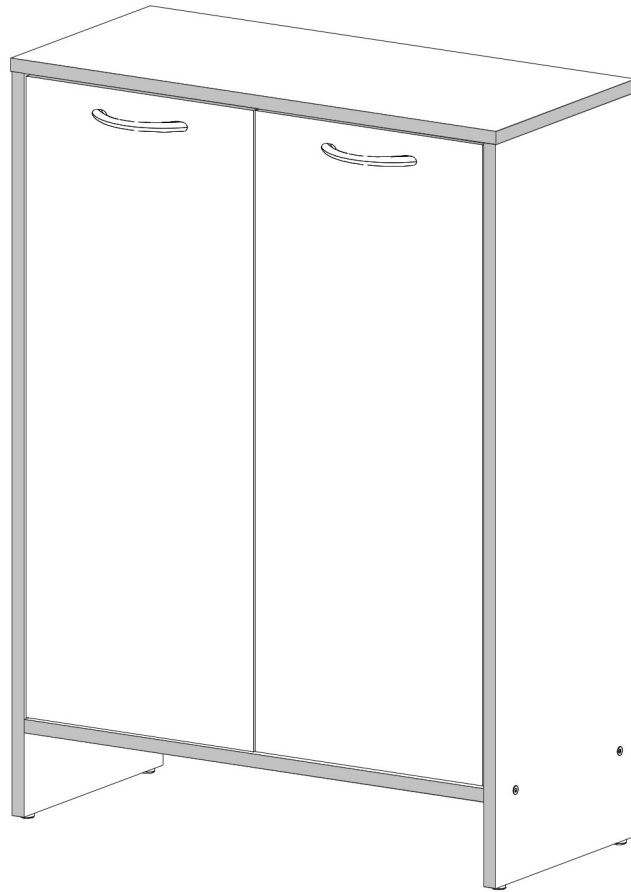





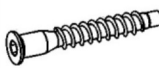





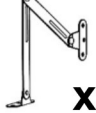



NINA 1K1D

PRODUCTION DATE

PACKING CODE



E1  8x30mm x10	F1  7x50mm x6	F3  Hex 4mm x1	N1  L=35mm x6	M1  12x15mm x6	T1  x4	U15  L=125mm x2	V26  x1		
S2  4x27mm x4	Z1  x50	A2  Zw x4	S1  3,5x16mm x12	V23  5,5x10,5mm x2	B2  Ant ø12/4mm x4	B2  S/A ø12/4mm x4	B2  B ø12/4mm x4		
B2  K ø12/4mm x4	V13  x1	V16  5x16mm x8							



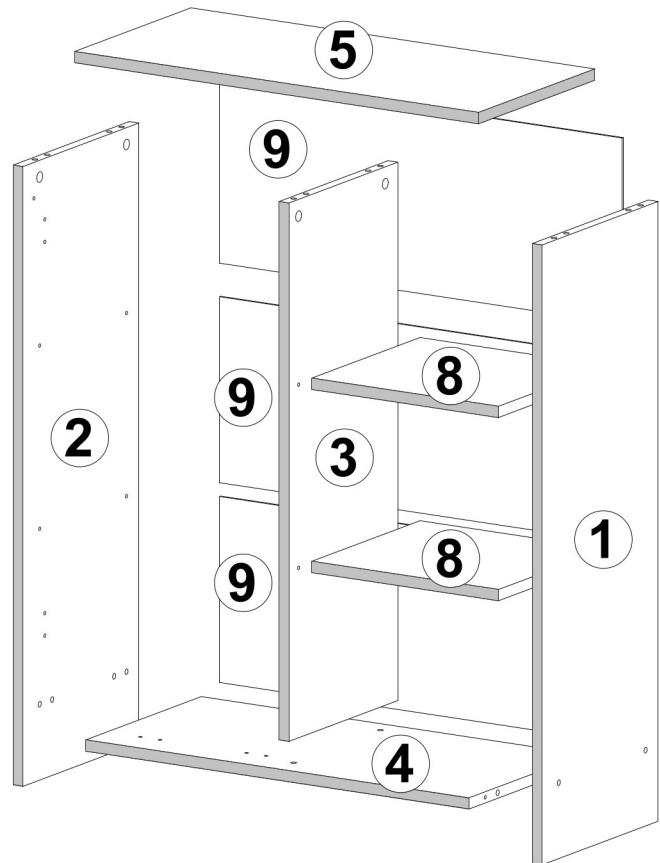
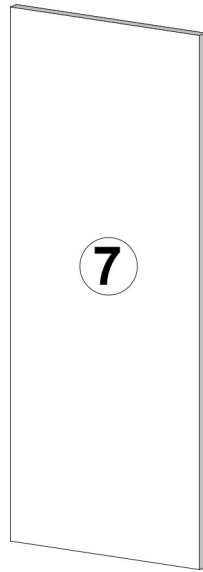
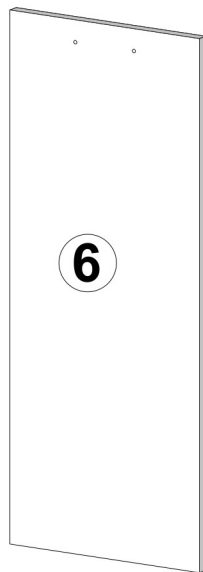

NINA 1K 1D

PRODUCTION DATE





PACKING CODE

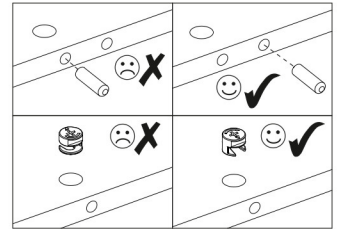
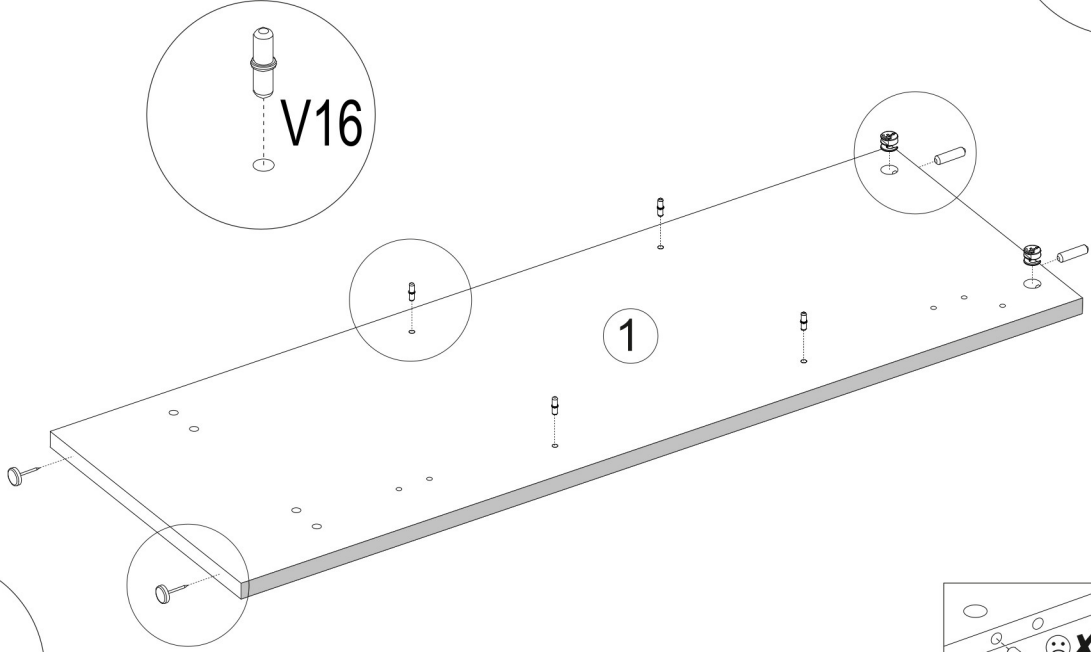
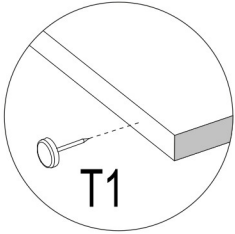
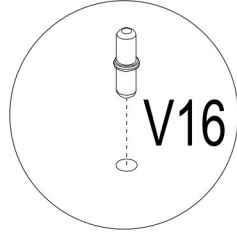
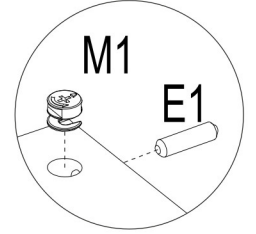

001967	1	1
001968	2	1
001974	3	1
001975	4	1
001976	5	1
001971	6	1
001970	7	1
001973	8	2
001972	9	3
ID	NUMBER	QUANTITY

E1  8x30mm x2	T1  x2	M1  12x15mm x2	V16  5x16mm x4
---	---	---	---



E1  8x30mm x2	T1  x2	M1  12x15mm x2	V23  5.5x10.5mm x2
---	---	---	---

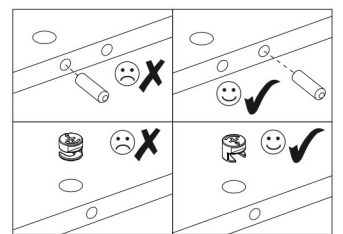
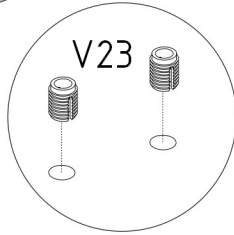
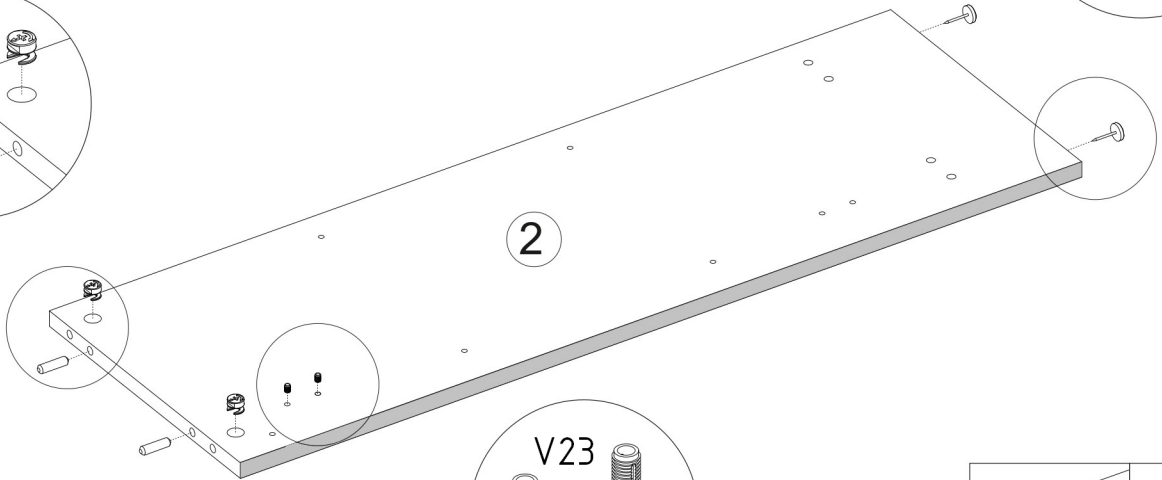
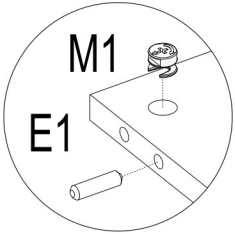
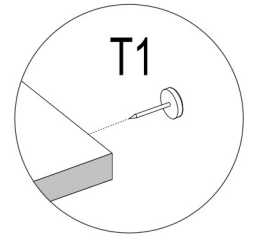

E1  8x30mm x2	M1  12x15mm x2	V16  5x16mm x4
---	---	---

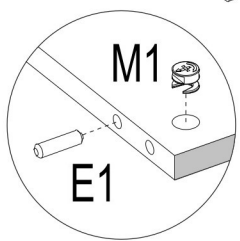
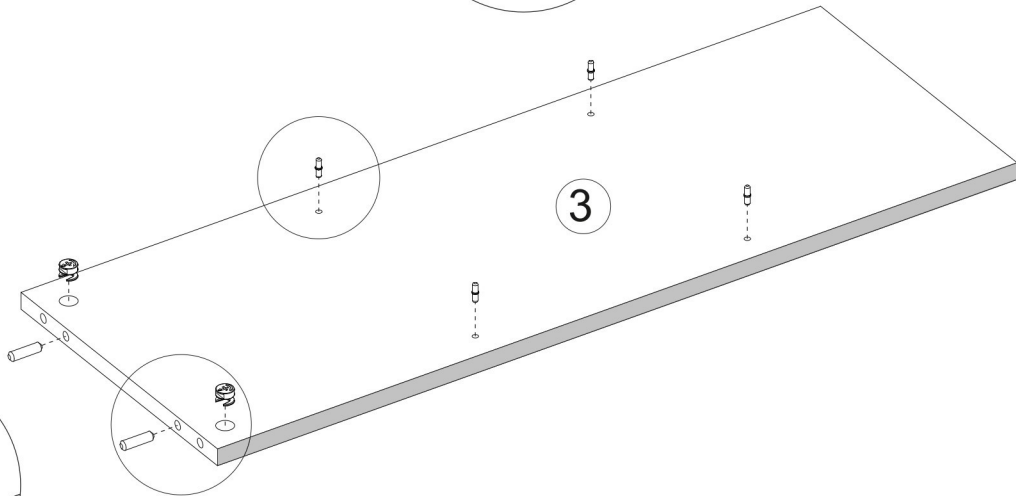
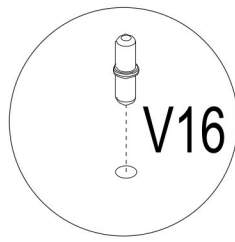
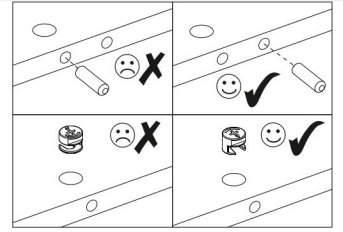

E1  8x30mm x4

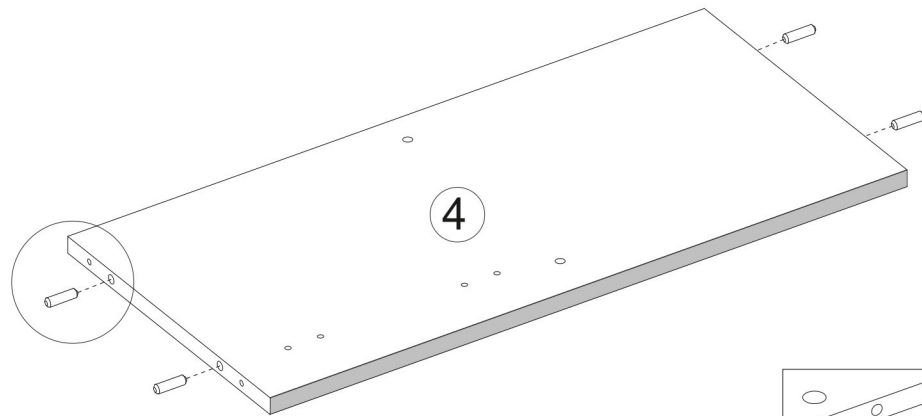
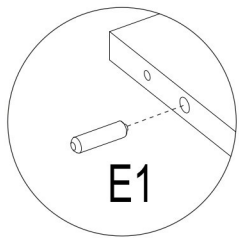
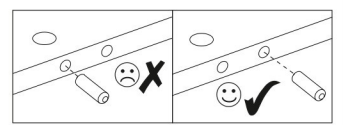



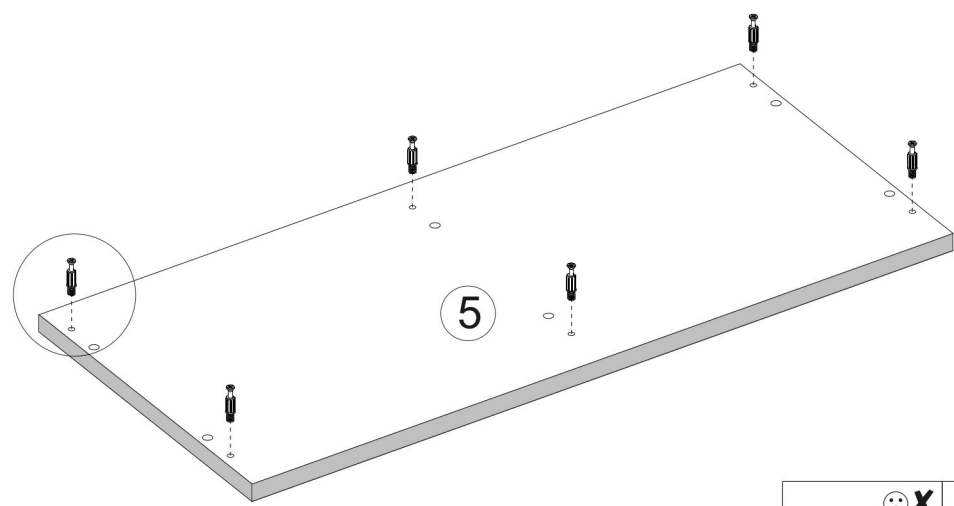
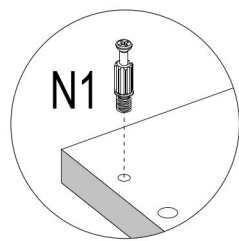
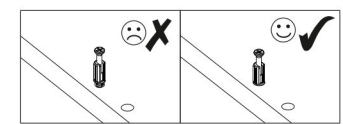

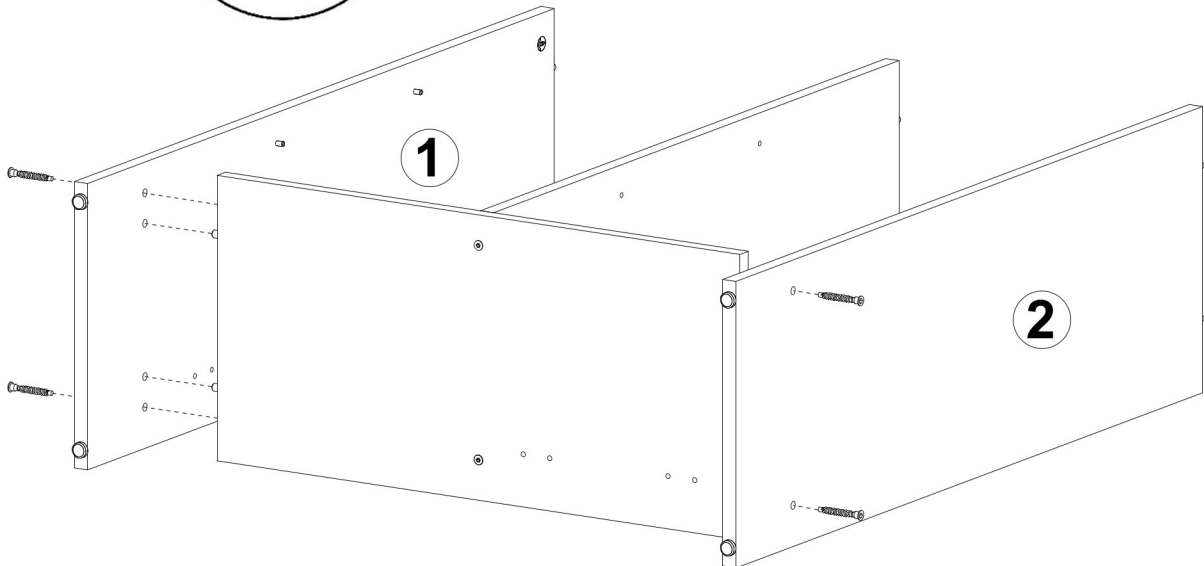
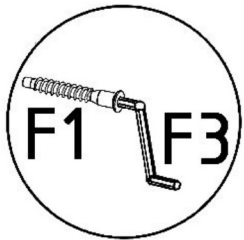
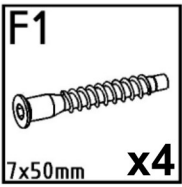
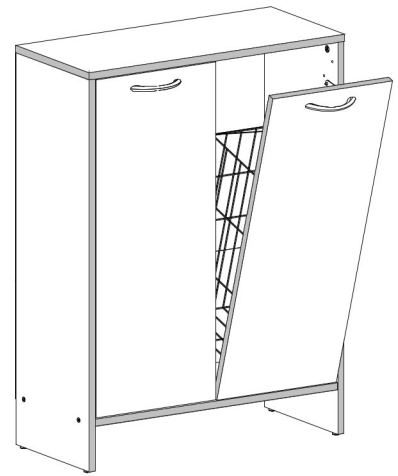
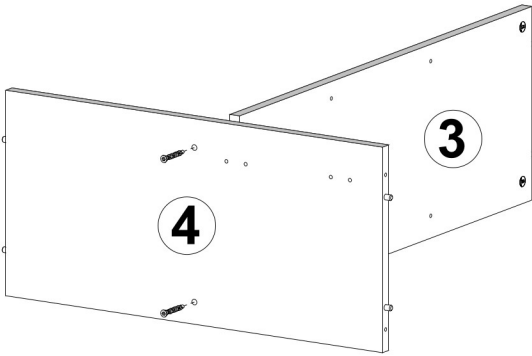
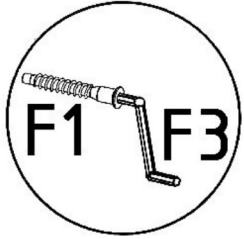
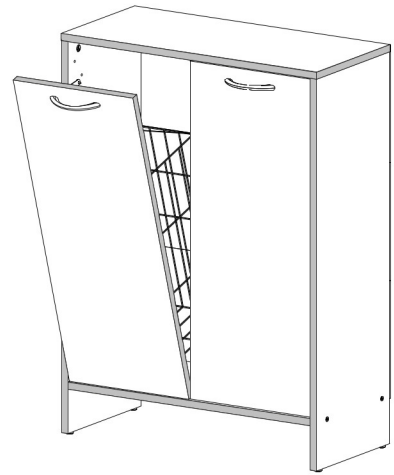
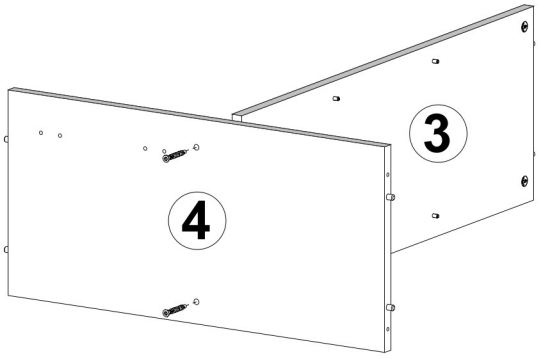
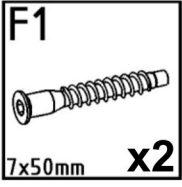
N1  L=35mm x6

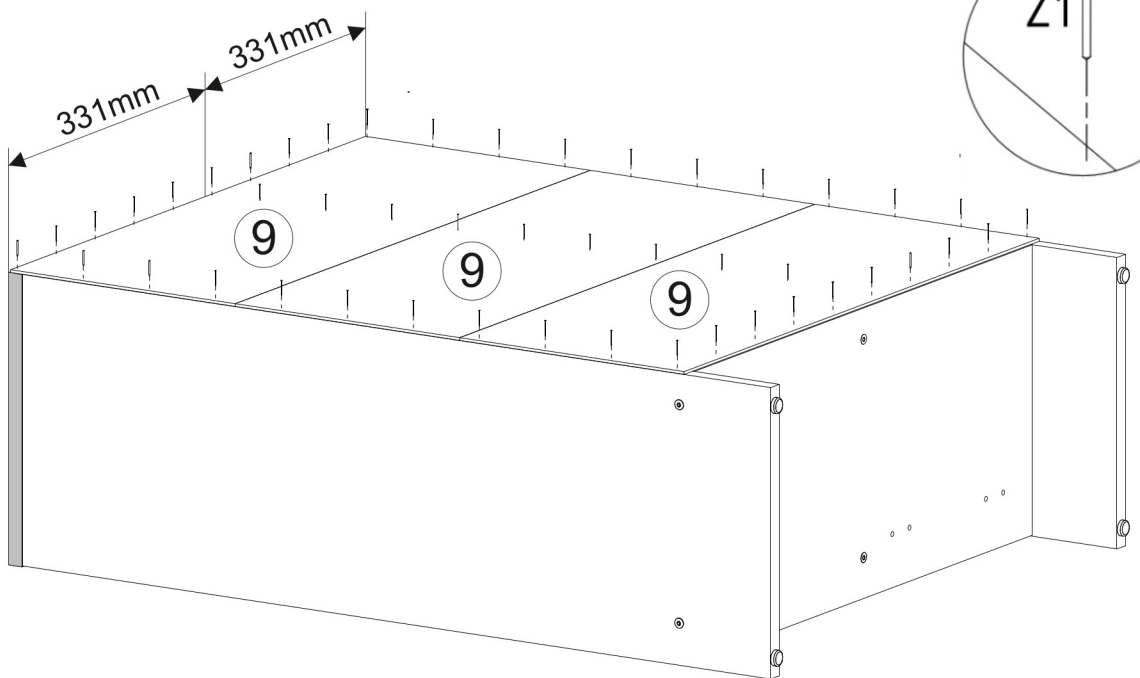
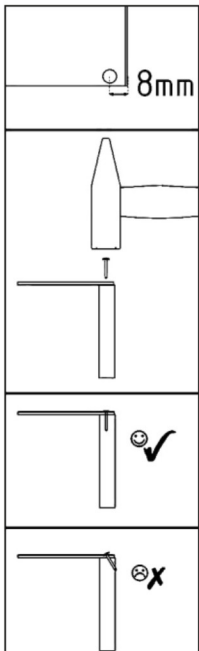
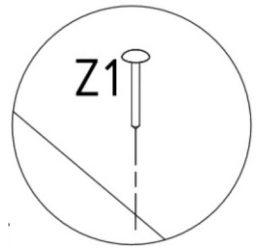
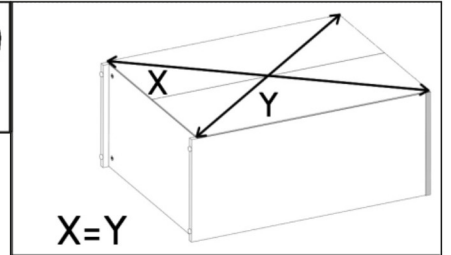
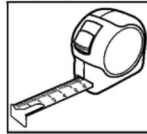
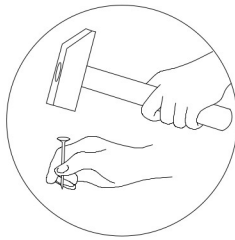
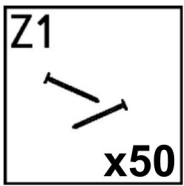
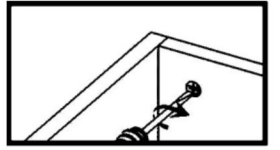
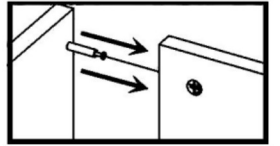
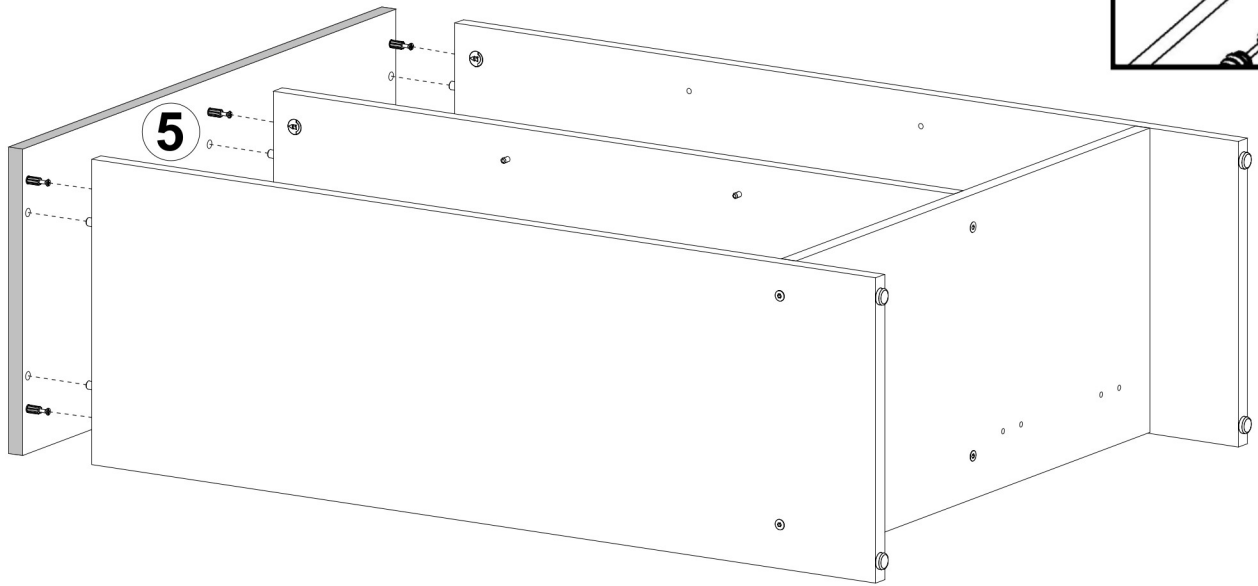







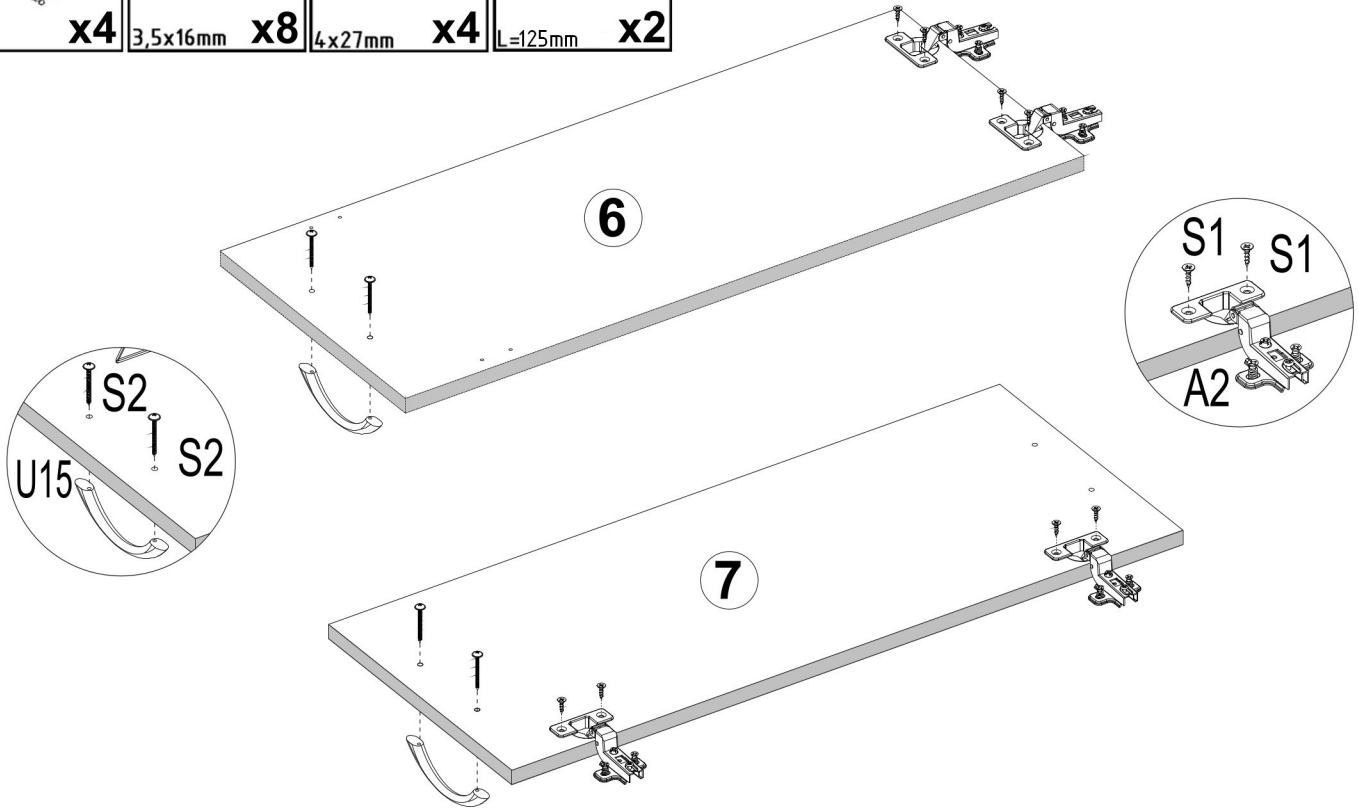

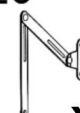

<p>A2</p>  <p>ZW x4</p>	<p>S1</p>  <p>3,5x16mm x8</p>	<p>S2</p>  <p>4x27mm x4</p>	<p>U15</p>  <p>L=125mm x2</p>
---	--	--	--

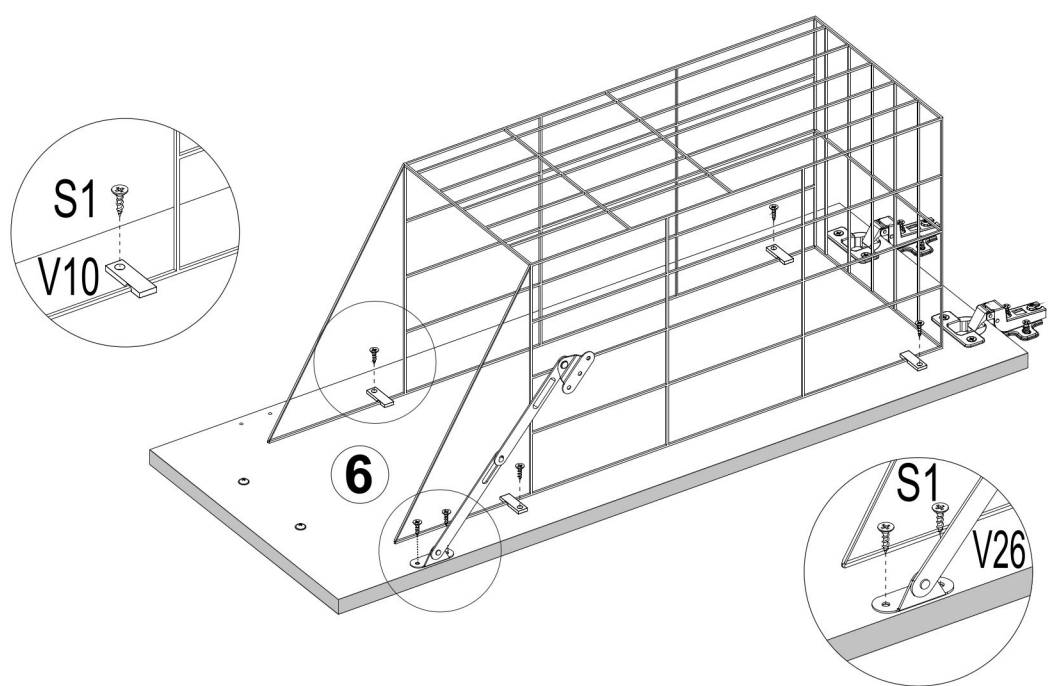

<p>V26</p>  <p>x1</p>	<p>S1</p>  <p>3,5x16mm x2</p>	<p>V9</p>  <p>x1</p>	<p>V10</p>  <p>x4</p>	<p>V11</p>  <p>3,5x16mm x4</p>
---	--	---	--	---



<p>V13</p>  <p>x1</p>	<p>B2</p>  <p>ø12/4mm x4</p>
---	---

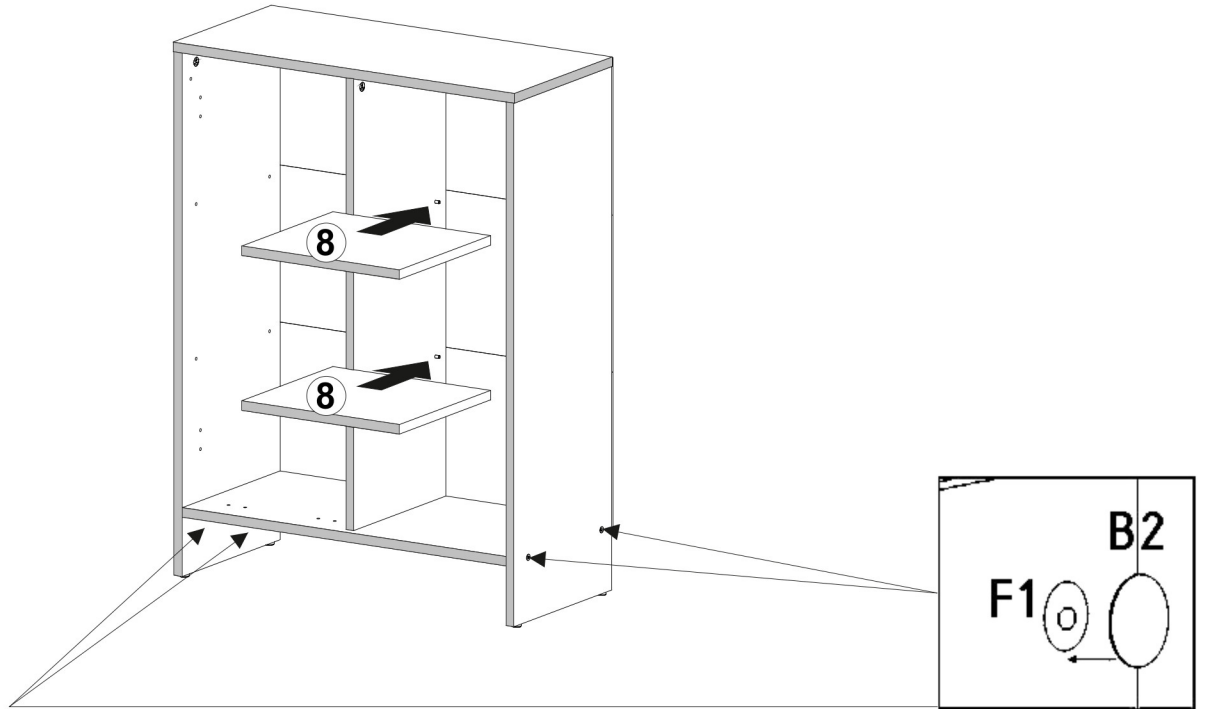
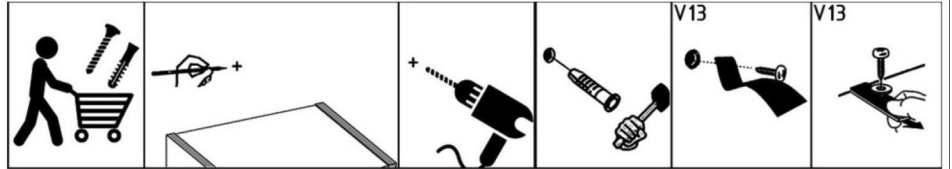

<p>S1</p>  <p>3,5x16mm x2</p>

